

Hypertherm®

Powermax65/85/105 SYNC™

Cut Charts Guide

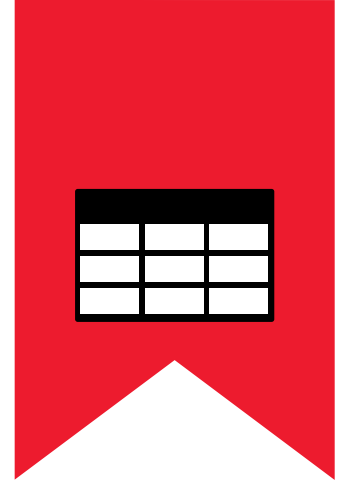

810500MU – REVISION 1

MULTILINGUAL



Powermax, SYNC, SmartSYNC, and Hypertherm are trademarks of Hypertherm, Inc. and may be registered in the United States and other countries. All other trademarks are the property of their respective holders.

Environmental stewardship is one of Hypertherm's core values, and it is critical to our success and our customers' success. We are striving to reduce the environmental impact of everything we do. For more information: www.hypertherm.com/environment.

© 2021 Hypertherm, Inc.

Powermax65/85/105 SYNC

Cut Charts Guide

810500MU
REVISION 1

MULTILINGUAL
Multilingual instructions

February 2021

Hypertherm, Inc.
Hanover, NH 03755 USA
www.hypertherm.com

Hypertherm, Inc.

Etna Road, P.O. Box 5010

Hanover, NH 03755 USA

603-643-3441 Tel (Main Office)

603-643-5352 Fax (All Departments)

info@hypertherm.com (Main Office Email)

800-643-9878 Tel (Technical Service)

technical.service@hypertherm.com (Technical Service Email)

800-737-2978 Tel (Customer Service)

customer.service@hypertherm.com (Customer Service Email)

866-643-7711 Tel (Return Materials Authorization)**877-371-2876 Fax (Return Materials Authorization)**

return.materials@hypertherm.com (RMA email)

Hypertherm México, S.A. de C.V.

Avenida Toluca No. 444, Anexo 1,

Colonia Olivar de los Padres

Delegación Álvaro Obregón

México, D.F. C.P. 01780

52 55 5681 8109 Tel

52 55 5683 2127 Fax

Soporte.Tecnico@hypertherm.com (Technical Service Email)

Hypertherm Plasmatechnik GmbH

Sophie-Scholl-Platz 5

63452 Hanau

Germany

00 800 33 24 97 37 Tel

00 800 49 73 73 29 Fax

31 (0) 165 596900 Tel (Technical Service)**00 800 4973 7843 Tel (Technical Service)**

technicalservice.emea@hypertherm.com (Technical Service Email)

Hypertherm (Singapore) Pte Ltd.

82 Genting Lane

Media Centre

Annexe Block #A01-01

Singapore 349567, Republic of Singapore

65 6841 2489 Tel

65 6841 2490 Fax

Marketing.asia@hypertherm.com (Marketing Email)

TechSupportAPAC@hypertherm.com (Technical Service Email)

Hypertherm Japan Ltd.

Level 9, Edobori Center Building

2-1-1 Edobori, Nishi-ku

Osaka 550-0002 Japan

81 6 6225 1183 Tel

81 6 6225 1184 Fax

HTJapan.info@hypertherm.com (Main Office Email)

TechSupportAPAC@hypertherm.com (Technical Service Email)

Hypertherm Europe B.V.

Vaartveld 9, 4704 SE

Roosendaal, Nederland

31 165 596907 Tel

31 165 596901 Fax

31 165 596908 Tel (Marketing)

31 (0) 165 596900 Tel (Technical Service)**00 800 4973 7843 Tel (Technical Service)**

technicalservice.emea@hypertherm.com

(Technical Service Email)

Hypertherm (Shanghai) Trading Co., Ltd.

B301, 495 ShangZhong Road

Shanghai, 200231

PR China

86-21-80231122 Tel

86-21-80231120 Fax

86-21-80231128 Tel (Technical Service)

techsupport.china@hypertherm.com

(Technical Service Email)

South America & Central America: Hypertherm Brasil Ltda.

Rua Bras Cubas, 231 – Jardim Maia

Guarulhos, SP – Brasil

CEP 07115-030

55 11 2409 2636 Tel

tecnico.sa@hypertherm.com (Technical Service Email)

Hypertherm Korea Branch

#3904. APEC-ro 17. Heaundae-gu. Busan.

Korea 48060

82 (0)51 747 0358 Tel

82 (0)51 701 0358 Fax

Marketing.korea@hypertherm.com (Marketing Email)

TechSupportAPAC@hypertherm.com

(Technical Service Email)

Hypertherm Pty Limited

GPO Box 4836

Sydney NSW 2001, Australia

61 (0) 437 606 995 Tel

61 7 3219 9010 Fax

au.sales@Hypertherm.com (Main Office Email)

TechSupportAPAC@hypertherm.com

(Technical Service Email)

Hypertherm (India) Thermal Cutting Pvt. Ltd

A-18 / B-1 Extension,

Mohan Co-Operative Industrial Estate,

Mathura Road, New Delhi 110044, India

91-11-40521201/ 2/ 3 Tel

91-11 40521204 Fax

HTIndia.info@hypertherm.com (Main Office Email)

TechSupportAPAC@hypertherm.com

(Technical Service Email)



For training and education resources, go to the Hypertherm Cutting Institute (HCI) online at www.hypertherm.com/hci.

Contents

Using the Cut Charts (English).....	7
使用切割表 (简体中文/ Simplified Chinese)	9
使用切割表 (繁體中文/ Traditional Chinese).....	11
Používání tabulek parametrů (Česky/Czech).....	13
Utilisation des tableaux de coupe (Français/French).....	15
Verwendung der Schneidtabellen (Deutsch/German)	17
Menggunakan Bagan Pemotongan (Bahasa Indonesia/Indonesian)	19
Utilizzo delle tabelle di taglio (Italiano/Italian)	21
切断条件表の使用法 (日本語/ Japanese).....	23
절단 도표 사용(한국어/Korean).....	25
Korzystanie z wykresów cięcia (Polski/Polish).....	27
Como usar as tabelas de corte (Português/Portuguese).....	29
Использование технологических карт резки (Русский/Russian).....	31
Cómo utilizar las tablas de corte (Español/Spanish).....	33
การใช้แผนภูมิการตัด (ภาษาไทย/Thai).....	35
Kesim Tablolarının Kullanılması (Türkçe/Turkish).....	37

Sử dụng Biểu đồ Cắt (Tiếng Việt/Vietnamese) 39

Cut charts 41

- Mild Steel – 105 A – Air 41
- Stainless Steel – 105 A – Air 42
- Aluminum – 105 A – Air 43
- Mild Steel – 85 A – Air 44
- Stainless Steel – 85 A – Air 45
- Aluminum – 85 A – Air 46
- Mild Steel – 65 A – Air 47
- Stainless Steel – 65 A – Air 48
- Aluminum – 65 A – Air 49
- Mild Steel – 45 A – Air 50
- Stainless Steel – 45 A – Air 51
- Aluminum – 45 A – Air 52
- Mild Steel – FineCut High Speed – Air 53
- Stainless Steel – FineCut High Speed – Air 54
- Mild Steel – FineCut Low Speed – Air 55
- Stainless Steel – FineCut Low Speed – Air 56

⚠ WARNING



EXPLOSION HAZARD – CUTTING WITH ALUMINUM NEAR WATER

Underwater cutting with fuel gases or aluminum can cause an explosion hazard.

- Do NOT cut under water with fuel gases that contain hydrogen.
- Do NOT cut aluminum alloys under water or on a water table, unless you can prevent the accumulation of hydrogen gas.

Doing so can cause an explosion during cutting system operation. Refer to the *Safety and Compliance Manual* (80669C) for more information.

⚠ WARNING



EXPLOSION HAZARD – CUTTING WITH FLAMMABLE OR OXIDIZING GASES

Do not use flammable or oxidizing gases with Powermax systems. These gases can cause explosive conditions during plasma cutting operations.

An example of an oxidizing gas is oxygen. Examples of flammable gases are acetylene, propylene, methane, and pure hydrogen. Refer to the *Safety and Compliance Manual* (80669C) for more information.

For more information

- For information about integrating your Powermax® system with a mechanized cutting setup, refer to the *Powermax65/85/105 SYNC Mechanized Cutting Guide* (810480).
- For additional information about your system refer to the *Powermax65/85/105 SYNC Operator Manual* (810470).

Download these documents at www.hypertherm.com/docs.

About the cut charts

The cut charts in this guide are a good starting point. Adjust the variables in the cut charts as needed to get optimal results for your cutting equipment and environment.

Cut charts are included for the following:

- Cutting mild steel, stainless steel, and aluminum at 45 A – 105 A with air using standard cutting cartridges
- Cutting mild steel and stainless steel with air using FineCut cartridges

Hypertherm collected the cut chart data using new cartridges and obeying all requirements for electric supply, gas supply, and site conditions.

Select the best cartridge for the material you want to cut

	Metric material thickness (mm)											
	0.5	1	2	3	5	8	10	12	15	20	25	30
FineCut	Black	Black	Black	Black	Black	Black	Black	Black	Black	Black	Black	Black
45 A	Light Gray	Light Gray	Light Gray	Light Gray	Light Gray	Light Gray	Light Gray	Light Gray	Light Gray	Light Gray	Light Gray	Light Gray
65 A	Light Gray	Light Gray	Light Gray	Light Gray	Light Gray	Light Gray	Light Gray	Light Gray	Light Gray	Light Gray	Light Gray	Light Gray
85 A	Light Gray	Light Gray	Light Gray	Light Gray	Light Gray	Light Gray	Light Gray	Light Gray	Light Gray	Light Gray	Light Gray	Light Gray
105 A	Light Gray	Light Gray	Light Gray	Light Gray	Light Gray	Light Gray	Light Gray	Light Gray	Light Gray	Light Gray	Light Gray	Light Gray

Optimal cut quality
Near to optimal cut quality
Decreased cut quality or speed

	English material thickness (in.)										
	0.02	0.06	1/8	1/4	3/8	1/2	5/8	3/4	1	1-1/4	1-1/2
FineCut	Black	Black	Black	Black	Black	Black	Black	Black	Black	Black	Black
45 A	Light Gray	Light Gray	Light Gray	Light Gray	Light Gray	Light Gray	Light Gray	Light Gray	Light Gray	Light Gray	Light Gray
65 A	Light Gray	Light Gray	Light Gray	Light Gray	Light Gray	Light Gray	Light Gray	Light Gray	Light Gray	Light Gray	Light Gray
85 A	Light Gray	Light Gray	Light Gray	Light Gray	Light Gray	Light Gray	Light Gray	Light Gray	Light Gray	Light Gray	Light Gray
105 A	Light Gray	Light Gray	Light Gray	Light Gray	Light Gray	Light Gray	Light Gray	Light Gray	Light Gray	Light Gray	Light Gray

Cut chart elements

The following illustration identifies the elements that are on each cut chart.

1
Mild Steel – 105 A – Air



428895 ohmic sensing ring

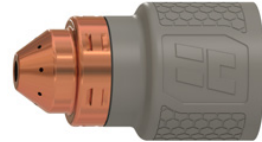

428936

2 Metric

Material Thickness	Cut Height	Initial Pierce Height		Pierce Delay	Best Quality		Highest Production		Kerf Width
		mm	%		seconds	Cut Speed	Arc Voltage	Cut Speed	
6	3.2	6.4	200	0.5	3960	143	4880	143	2.2
20				1.0	790	153	940	152	2.8
40				Edge start		200	172	250	170

2 English

Material Thickness	Cut Height	Initial Pierce Height		Pierce Delay	Best Quality		Highest Production		Kerf Width
		inches	%		seconds	in/min	volts	in/min	
1/4	0.125	0.25	200	0.5	156	143	192	143	0.086
3/4				1.0	33	152	40	151	0.108
1-1/2				Edge start		9	170	10	168

4 Gas flow rate – slpm / scfh

236 / 500	Hot (cutflow)
311 / 660	Cold (postflow)

1 Type of metal:

- Mild Steel
- Stainless Steel
- Aluminum

Cut process:

- **A** = Amperage. The amperage applies to all the settings on that page.
- In **FineCut** charts, the amperage for each thickness is included in the cut chart. This guide includes high-speed and low-speed charts. High-speed settings can give better cut quality and less dross at some thicknesses, if the cutting table lets you cut at those settings.

Type of gas:

- Air (or nitrogen)

Use an **ohmic sensing ring** to connect a mechanized cartridge to a torch height control (THC) system. Install it on the cartridge as shown. The 428895 kit includes 3 ohmic sensing rings (420580).

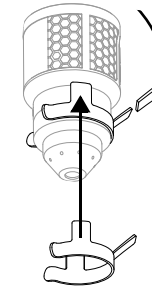

3 Units of measurement:

- mm = millimeters
- % = percentage
- seconds
- mm/min = millimeters per minute
- volts
- inches
- in/min = inches per minute
- A = amperage (FineCut charts)

Edge start = Start the cut from the edge of the workpiece.

2 Metric = Metric measurements

English = English measurements

Material Thickness = Thickness of the workpiece (metal plate being cut).

Cut Height = Distance between the tip of the cartridge and the workpiece during cutting.

Initial Pierce Height = Distance between the tip of the cartridge and the workpiece when the torch is fired, prior to descending to the cut height.

Pierce Delay = Length of time the plasma arc remains stationary at the pierce height while it cuts through the workpiece.

Best Quality (Cut Speed and Arc Voltage*) = Settings that provide the starting point for finding the best cut quality (best angle, least dross, best cut-surface finish). Adjust the speed for your application and cutting system to get the desired result.

Highest Production (Cut Speed and Arc Voltage*) = Settings that increase cut speeds 20% – 30%. These speeds give an increased number of cut parts but not necessarily the best possible cut quality.

Kerf Width = Width of material removed by the cutting process. The kerf widths are for reference only. Hypertherm got them using the “Best Quality” settings. Differences between installations and material composition can cause actual results to vary from those shown in the tables.

* For information on how to use arc voltage to control cut height, refer to the *Powermax65/85/105 SYNC Mechanized Cutting Guide* (810480).

4 Each cut chart lists hot and cold gas flow rates.

- slpm = Standard liter per minute
- scfh = Standard cubic feet per hour

Hot (cutflow) = Plasma arc is on, and there is a steady flow of gas while cutting.

Cold (postflow) = Plasma arc is off, and there is a steady flow of gas for several seconds after the cut completes. This flow rate also applies for gas test mode.

使用切割表 (简体中文 / Simplified Chinese)

警告



爆炸危险 — 在水附近切割铝材

使用燃料气体进行水下切割或水下切割铝材可能造成爆炸危险。

- 切勿使用含有氢气的气体燃料进行水下切割。
- 除非您可以防止氢气积聚，否则，切勿在水下或水床上切割铝合金。

如不遵守上述规定，切割系统作业期间可能引起爆炸。有关详细信息，请参阅 *Safety and Compliance Manual* 《安全和法规遵守手册》(80669C)。

警告



爆炸危险 — 用易燃或氧化气体进行切割

不要在 Powermax 系统中使用易燃或氧化气体。在等离子切割作业期间，这些气体可能会形成爆炸条件。

氧气便是氧化气体之一。易燃气体的例子包括乙炔、丙烯、甲烷和纯氢气。有关详细信息，请参阅 *Safety and Compliance Manual* 《安全和法规遵守手册》(80669C)。

索取详细信息

- 如需了解如何将 Powermax® 系统与机用切割环境进行整合，请参阅 *Powermax65/85/105 SYNC Mechanized Cutting Guide* 《Powermax65/85/105 SYNC 机用切割指南》(810480)。
- 有关您的系统的更多详情，请参阅 *Powermax65/85/105 SYNC Operator Manual* 《Powermax65/85/105 SYNC 操作手册》(810470)。

可访问 www.hypertherm.com/docs 下载这些文档。

关于切割表

本指南中的切割表可以作为良好的初始设置。您可以根据需要调整切割表中的变量，以便让您的切割设备和环境实现最优的效果。

包括适用于以下情况的切割表：

- 在 45 A ~ 105 A 下结合使用空气和标准切割筒切割低碳钢、不锈钢和铝材
- 结合使用空气和 FineCut 切割筒切割低碳钢和不锈钢

海宝通过新切割筒收集切割表数据，并且在收集过程中遵循有关供电、供气和站点条件的所有要求。

选择最适合待切割材料的喷头

切割表	公制材料厚度 (mm)											
	0.5	1	2	3	5	8	10	12	15	20	25	30
FineCut	最佳	最佳	最佳	最佳	最佳	接近	降低	降低	降低	降低	降低	降低
45 A	接近	接近	接近	接近	接近	降低	降低	降低	降低	降低	降低	降低
65 A	降低	降低	降低	降低	降低	降低	降低	降低	降低	降低	降低	降低
85 A	降低	降低	降低	降低	降低	降低	降低	降低	降低	降低	降低	降低
105 A	降低	降低	降低	降低	降低	降低	降低	降低	降低	降低	降低	降低

最佳切割质量
接近最佳切割质量
切割质量或速度降低

切割表	英制材料厚度 (英寸)										
	0.02	0.06	1/8	1/4	3/8	1/2	5/8	3/4	1	1-1/4	1-1/2
FineCut	最佳	最佳	最佳	最佳	接近	降低	降低	降低	降低	降低	降低
45 A	接近	接近	接近	接近	降低	降低	降低	降低	降低	降低	降低
65 A	降低	降低	降低	降低	降低	降低	降低	降低	降低	降低	降低
85 A	降低	降低	降低	降低	降低	降低	降低	降低	降低	降低	降低
105 A	降低	降低	降低	降低	降低	降低	降低	降低	降低	降低	降低

切割表组成部分

下方示意图列出了每张切割表上均有的组成部分。

1
Mild Steel - 105 A - Air

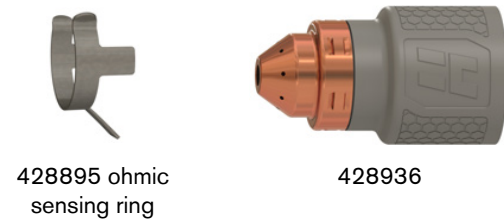

428895 ohmic sensing ring

428936

2 Metric

Material Thickness	Cut Height	Initial Pierce Height		Pierce Delay	Best Quality		Highest Production		Kerf Width
		mm	%		seconds	Cut Speed	Arc Voltage	Cut Speed	
6	3.2	6.4	200	0.5	3960	143	4880	143	2.2
20				1.0	790	153	940	152	2.8
40				Edge start		200	172	250	170

2 English

Material Thickness	Cut Height	Initial Pierce Height		Pierce Delay	Best Quality		Highest Production		Kerf Width
		inches	%		seconds	in/min	volts	in/min	
1/4	0.125	0.25	200	0.5	156	143	192	143	0.086
3/4				1.0	33	152	40	151	0.108
1-1/2				Edge start		9	170	10	168

4 Gas flow rate - slpm / scfh

236 / 500	Hot (cutflow)
311 / 660	Cold (postflow)

1 材料类型:

- 低碳钢
- 不锈钢
- 铝

切割工艺:

- **A** = 安培数。安培数设定适用于该页的所有设定。
- 在 **FineCut** 表中, 列出了切割表中每种厚度对应的安培数。本指南包含高速和低速切割表。在切割某些厚度的材料时, 如果切割床允许在这些设置下进行切割, 高速设置可提高切割质量并减少熔渣。

气体类型:

- 空气 (或氮气)

使用欧姆感应环来将机用喷头连接到割炬调高控制器 (THC) 系统。如图所示, 将其安装到喷头上。428895 套件包含 3 个欧姆感应环 (420580)。

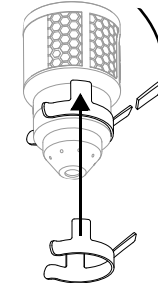

3 测量单位:

- mm = 毫米
- % = 百分比
- seconds = 秒
- mm/min = 毫米 / 分钟
- volts = 伏特
- inches = 英寸
- in/min = 英寸 / 分钟
- A = 安培数 (FineCut 表)

Edge start = 从工件边缘开始切割。

2 Metric = 公制

English = 英制

Material Thickness = 工件 (待切割的金属板) 的厚度。

Cut Height = 切割期间切割筒尖部与工件之间的距离。

Initial Pierce Height = 在割炬点火时, 在下降到切割高度之前, 切割筒尖部与工件之间的距离。

Pierce Delay = 在切穿工件的过程中, 等离子弧在穿孔高度位置保持静止状态的时间。

Best Quality (Cut Speed 和 Arc Voltage*) = 可获得最佳切割质量 (最佳角度、最少熔渣、最佳切割表面光洁度) 的起步设定。请根据您的用途和切割系统调整速度, 以达到所希望的切割质量。

Highest Production (Cut Speed 和 Arc Voltage*) = 可将切割速度提高 20% ~ 30% 的设定。这些速度条件下, 切割的零件数量会增加, 但切割的质量未必最佳。

Kerf Width = 由切割工艺去除的材料宽度。割缝宽度仅供参考。海宝 通过使用 Best Quality (最佳质量) 设定得出这些结果。切割设备和切割材料成分的差异可能导致实际结果与表中结果有所不同。

* 如需了解如何使用弧压来控制切割高度, 请参阅 Powermax65/85/105 SYNC Mechanized Cutting Guide 《Powermax65/85/105 SYNC 机用切割指南》(810480)。

4 每张切割表均列出了冷热气体流量。

- slpm = 每分钟标准升数
- scfh = 每小时标准立方英尺

Hot (cutflow) = 等离子弧已开启, 并且切割时有稳定气流。

Cold (postflow) = 等离子弧已关闭, 并且切割完成后的几秒钟内有稳定气流。此流量同样适用于气体测试模式。

使用切割表 (繁體中文 / Traditional Chinese)

警告



爆炸危險 – 靠近水使用鋁材切割

使用燃料氣體或鋁材進行水下切割可能會產生爆炸危險。

- 切勿使用含有氫氣的燃料氣體進行水下切割。
- 除非您可以防止氫氣積聚，否則切勿在水下或水床上切割鋁合金。

在切割系統運行中如此做可能會引起爆炸。請參閱 *Safety and Compliance Manual* (安全和法規遵循手冊)(80669C)，瞭解更多資訊。

警告



爆炸危險 – 使用易燃或氧化氣體切割

操作 Powermax 系統時，請勿使用易燃或氧化氣體。這些氣體可能在電漿切割操作中引起爆炸。

例如，氧氣屬於氧化氣體的一種。易燃氣體包括乙炔、丙烯、甲烷，及純氫氣。請參閱 *Safety and Compliance Manual* (安全和法規遵循手冊)(80669C)，瞭解更多資訊。

查詢詳情

- 若要查詢更多關於將 Powermax® 系統整合至機用切割設定詳情，請詳閱 *Powermax65/85/105 SYNC Mechanized Cutting Guide* (機用切割指南) (810480)。
- 若要查詢更多關於系統的詳情，請參閱 *Powermax65/85/105 SYNC Operator Manual* (*Powermax65/85/105 SYNC 操作手冊*) (810470)。

請在此網站：www.hypertherm.com/docs 下載這些文件。

關於切割表

為了能熟悉此項作業，請先詳閱本指南中的切割表。視需要調整切割表中的變數，可為切割設備及環境達到最佳化的結果。

以下項目中皆包含切割表：

- 以 45 A – 105 A 電源，使用標準切割夾頭以空氣切割低碳鋼、不銹鋼和鋁
- 使用 FineCut 夾頭以空氣切割低碳鋼及不銹鋼

Hypertherm 使用新夾頭收集切割表數據，並遵守電力供應、供氣和現場條件的所有要求。

為您要切割的材料選擇最佳的夾頭

夾頭	公制材料厚度 (mm)											
	0.5	1	2	3	5	8	10	12	15	20	25	30
FineCut	最佳	最佳	最佳	最佳	最佳	接近	降低	降低	降低	降低	降低	降低
45 A	接近	接近	接近	接近	接近	接近	接近	接近	接近	接近	接近	接近
65 A	降低	降低	降低	降低	降低	降低	降低	降低	降低	降低	降低	降低
85 A	降低	降低	降低	降低	降低	降低	降低	降低	降低	降低	降低	降低
105 A	降低	降低	降低	降低	降低	降低	降低	降低	降低	降低	降低	降低

最佳切割品質
接近最佳切割品質
降低切割品質或速度

夾頭	英制材料厚度 (英吋)										
	0.02	0.06	1/8	1/4	3/8	1/2	5/8	3/4	1	1-1/4	1-1/2
FineCut	最佳	最佳	最佳	最佳	接近	降低	降低	降低	降低	降低	降低
45 A	接近	接近	接近	接近	接近	接近	接近	接近	接近	接近	接近
65 A	降低	降低	降低	降低	降低	降低	降低	降低	降低	降低	降低
85 A	降低	降低	降低	降低	降低	降低	降低	降低	降低	降低	降低
105 A	降低	降低	降低	降低	降低	降低	降低	降低	降低	降低	降低

切割表元件

下圖顯示在每張切割表上的元件。

1

Mild Steel – 105 A – Air



428895 ohmic sensing ring



428936

2 Metric

Material Thickness	Cut Height	Initial Pierce Height		Pierce Delay	Best Quality		Highest Production		Kerf Width
		mm	%		seconds	Cut Speed	Arc Voltage	Cut Speed	
6	3.2	6.4	200	0.5	3960	143	4880	143	2.2
20				1.0	790	153	940	152	2.8
40				Edge start		200	172	250	170

2 English

Material Thickness	Cut Height	Initial Pierce Height		Pierce Delay	Best Quality		Highest Production		Kerf Width
		inches	%		seconds	in/min	volts	in/min	
1/4	0.125	0.25	200	0.5	156	143	192	143	0.086
3/4				1.0	33	152	40	151	0.108
1-1/2				Edge start		9	170	10	168

4 Gas flow rate – slpm / scfh

236 / 500	Hot (cutflow)
311 / 660	Cold (postflow)

1

金屬類型：

- 低碳鋼
- 不銹鋼
- 鋁

切割流程：

- A = 安培數。該頁面上的所有設定皆為安培數。
- 在 FineCut 表中，每種厚度的安培數皆包括在切割表中。本指南包括高速和低速圖表。如果切割台允許您在這些設定下進行切割，則高速設定可以提供更好的切割品質，並在某些厚度下減少浮渣。

氣體種類：

- 空氣 (或氮氣)

使用歐姆感應環將機械式夾頭連線至火炬高度控制器 (THC) 系統。如圖所示，將其安裝在夾頭上。428895 套件含有 3 個歐姆感應環 (420580)。

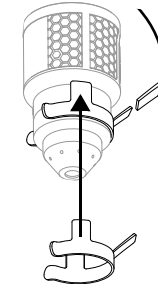

3

測量單位：

- mm = 毫米
- % = 百分比
- seconds = 秒
- mm/min = 每分鐘毫米數
- volts = 伏特
- inches = 英吋
- in/min = 每分鐘英吋數
- A = 安培 (FineCut 表)

Edge start = 從工件邊緣開始切割。

2

Metric = 公制測量單位

English = 英制測量單位

Material Thickness = 工件厚度 (被切割的金屬板料)。

Cut Height = 切割中的夾頭頂端與工件之間的距離。

Initial Pierce Height = 當火炬起弧 (在降低至切割高度前) 時，夾頭頂端與工件之間的距離。

Pierce Delay = 在切穿工件的過程中，電漿弧維持在穿孔高度保持靜止的時間長度。

Best Quality (Cut Speed 和 Arc Voltage*) = 尋找最佳切割品質起始點的設定 (最佳角度、最少熔渣、最佳切割表面處理)。可針對您的運用及切割系統進行調整，以達到最需要的效果。

Highest Production (Cut Speed 和 Arc Voltage*) = 增加 20% – 30% 切割速度的設定。這些速度可增加切割零件的數目，但是並不代表最佳切割品質。

Kerf Width = 被切割程序刪除的材料寬度。割縫寬度僅供參考。Hypertherm 根據「Best Quality (最佳品質)」設定計算得出。安裝及材料成分之間的差異，可造成實際結果異於表格所示。

* 關於如何使用電弧電壓控制切割高度的資訊，請參閱 Powermax65/85/105 SYNC Mechanized Cutting Guide (Powermax65/85/105 SYNC 機械化切割指南) (810480)。

4

每張切割表皆列出冷熱氣流量。

- slpm = 每分鐘標準公升
- scfh = 每小時標準立方英尺

Hot (cutflow) = 電漿弧開啟，切割過程中有穩定的切割氣流。

Cold (postflow) = 電漿電漿弧關閉，切割結束後有數秒鐘的穩定氣流。此氣流流量也適用於氣體測試模式。

Používání tabulek parametrů (Česky/Czech)

VAROVÁNÍ



NEBEZPEČÍ VÝBUCHU – ŘEZÁNÍ S HLINÍKEM BLÍZKO VODY

Řezání pod vodou hořlavými plyny nebo hliníkem s sebou nese nebezpečí výbuchu.

- Pod vodou NEŘEŽTE s hořlavými plyny, které obsahují vodík.
- Pokud nedokážete zabránit hromadění vodíku, NEŘEŽTE hliníkové slitiny pod vodou nebo na vodním stole.

Tímto způsobem může během plazmového řezání dojít k výbuchu. Podrobné informace viz *Safety and Compliance Manual (Manuál pro bezpečnost a dodržování předpisů)* (80669C).

VAROVÁNÍ



NEBEZPEČÍ VÝBUCHU – ŘEZÁNÍ S HOŘLAVÝMI PLYNY NEBO OXIDUJÍCÍMI PLYNY

Se systémy Powermax nepoužívejte hořlavé plyny ani oxidující plyny. Tyto plyny mohou při operacích plazmového řezání vytvořit výbušné prostředí.

Příkladem oxidujícího plynu je kyslík. Příkladem hořlavých plynů je acetylen, propylen, metan a čistý vodík. Podrobné informace viz *Safety and Compliance Manual (Manuál pro bezpečnost a dodržování předpisů)* (80669C).

Pokud potřebujete více informací

- Více informací o tom, jak lze integrovat váš systém Powermax® s nastavením mechanizovaného řezání, naleznete v *Powermax65/85/105 SYNC Mechanized Cutting Guide (Powermax65/85/105 SYNC Průvodce mechanizovaným řezáním)* (810480).
- Další informace o Vašem systému naleznete v *Powermax65/85/105 SYNC Operator Manual (Pracovním manuálu SYNC)* (810470).



Dokumenty můžete stáhnout na adrese www.hypertherm.com/docs.

O tabulkách parametrů

Tabulky parametrů v tomto průvodci jsou dobrým výchozím bodem. Nastavte proměnné v tabulkách parametrů tak, jak je potřeba k docílení optimálního výsledku řezacího zařízení a životního prostředí.

Tabulky parametrů jsou uvedeny pro:

- řezání nelegované oceli, nerezové oceli a hliníku při 45 A–105 A se vzduchem při použití standardních řezacích náplní,
- řezání nelegované oceli a nerezové oceli a se vzduchem při použití náplní FineCut,



Společnost Hypertherm shromáždila tabulky parametrů s použitím nových náplní a při dodržení všech požadavků na elektrické napájení, zdroj plynu a podmínky na pracovišti.

Zvolte nejlepší náplň pro typ materiálu, který chcete řezat

Tloušťka materiálu v metrických jednotkách (mm)	Tloušťka materiálu v metrických jednotkách (mm)											
	0,5	1	2	3	5	8	10	12	15	20	25	30
FineCut	■	■	■	■	■							
45 A	■	■	■	■	■							
65 A			■	■	■	■	■	■	■	■	■	■
85 A				■	■	■	■	■	■	■	■	■
105 A						■	■	■	■	■	■	■

Optimální kvalita řezu
Téměř optimální kvalita řezu
Snížená kvalita řezu nebo rychlost

Tloušťka materiálu v anglosaských jednotkách (palce)	Tloušťka materiálu v anglosaských jednotkách (palce)										
	0.02	0.06	1/8	1/4	3/8	1/2	5/8	3/4	1	1-1/4	1-1/2
FineCut	■	■	■								
45 A	■	■	■	■							
65 A			■	■	■	■	■	■	■	■	■
85 A				■	■	■	■	■	■	■	■
105 A						■	■	■	■	■	■

Prvky tabulek parametrů

Následující stránka názorně představuje prvky, které naleznete v každé tabulce parametrů.

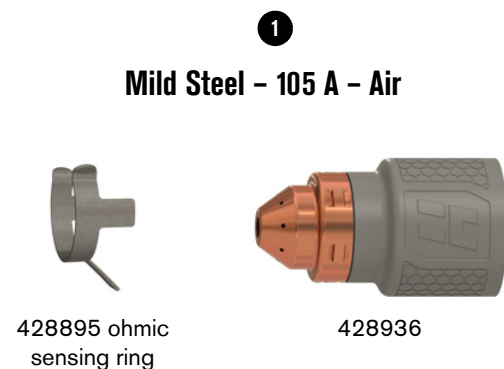

2 Metric

Material Thickness	Cut Height	Initial Pierce Height		Pierce Delay	Best Quality		Highest Production		Kerf Width
		mm	%		mm/min	volts	mm/min	volts	
6	3.2	6.4	200	0.5	3960	143	4880	143	2.2
20				1.0	790	153	940	152	2.8
40				Edge start		200	172	250	170

2 English

Material Thickness	Cut Height	Initial Pierce Height		Pierce Delay	Best Quality		Highest Production		Kerf Width
		inches	%		in/min	volts	in/min	volts	
1/4	0.125	0.25	200	0.5	156	143	192	143	0.086
3/4				1.0	33	152	40	151	0.108
1-1/2				Edge start		9	170	10	168

4 Gas flow rate – slpm / scfh

236 / 500	Hot (cutflow)
311 / 660	Cold (postflow)

1 Typ kovu:

- Nelegovaná (uhlíková) ocel
- Nerezová ocel
- Hliník

Řezací proces:

- **A** = Proudová intenzita. Proudová intenzita platí pro všechna nastavení uvedená na této stránce.
- V tabulkách parametrů **FineCut** je zahrnuta proudová intenzita pro jednotlivé tloušťky. Tento průvodce obsahuje tabulky pro vysoké rychlosti a nízké rychlosti. Vysokorychlostní nastavení může při některých tloušťkách poskytnout lepší kvalitu řezu a méně otřepů, pokud vám řezací stůl umožňuje řezat s těmito nastaveními.

Typ plynu:

- **Vzduch** (nebo dusík)

Ohmický snímací kroužek použijte pro připojení mechanizované náplně na systém řízení výšky hořáku (THC). Nasadte ho na náplň dle zobrazení. Sada 428895 obsahuje 3 ohmické snímací kroužky (420580).

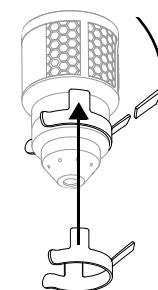

2 Metric = Metrické jednotky

English = Imperiální jednotky

Material Thickness = Tloušťka obrobku (řezaná kovová deska).

Cut Height = Vzdálenost mezi hrotem ochranné krytky a obrobkem během řezání.

Initial Pierce Height = Vzdálenost mezi ochrannou krytkou (stiněná) nebo tryskou (nestíněná) a obrobkem při zapálení hořáku před poklesem na řezací výšku.

Pierce Delay = Časový úsek, během něhož je plazmový oblouk nehybný v propalovací výšce, zatímco řeže skrz obrobek.

Best Quality (Cut Speed a Arc Voltage*) = Nastavení sloužící jako výchozí bod pro nalezení nejlepší kvality řezu (nejlepší úhel, nejméně otřepů a nejlepší provedení řezaného povrchu). Pro dosažení požadovaného výsledku seřídte rychlost v závislosti na aplikaci a řezacím systému.

Highest Production (Cut Speed a Arc Voltage*) = Nastavení, která zvýší řeznou rychlost o 20 %–30 %. Tyto rychlosti přinesou vyšší počet vyřiznutých dílů, ale nutně neznamenají nejlepší možnou kvalitu řezu.

Kerf Width = Šířka materiálu, který je při řezání odstraněn. Uvedené šířky jsou pouze informační. Společnost Hypertherm je získala při použití nastavení „Nejlepší kvalita“. Rozdíly mezi jednotlivými instalacemi a složením jednotlivých materiálů mohou způsobit odlišnost skutečných výsledků od hodnot uvedených v tabulkách.

* Informace o tom, jak využít napětí na oblouku k řízení výšky řezu, viz *Powermax65/85/105 SYNC Mechanized Cutting Guide (Průvodce mechanizovaným řezáním)* (810480).

3 Jednotky měření:

- **mm** = milimetry
- **%** = procentuální hodnota
- **seconds** = sekundy
- **mm/min** = milimetry za minutu
- **volts** = volty
- **inches** = palce
- **in/min** = palce za minutu
- **A** = proudová intenzita (tabulky FineCut)

Edge start = Začátek řezu od okraje obrobku.

4 Každá tabulka parametrů řezání uvádí průtoky horkého a studeného vzduchu.

- **slpm** = standardní litr za minutu
- **scfh** = standardní krychlová stopa za minutu

Hot (cutflow) = Plazmový oblouk je zapnutý a při řezání plyn proudí konstantně.

Cold (postflow) = Plazmový oblouk je vypnutý a plyn proudí konstantně po dobu několika sekund po dokončení řezu. Toto průtočné množství platí i pro zkušební režim plynu.

Utilisation des tableaux de coupe (Français/French)

⚠ AVERTISSEMENT

RISQUE D'EXPLOSION – COUPE AVEC DE L'ALUMINIUM À PROXIMITÉ D'UNE SOURCE D'EAU

La coupe sous l'eau avec des gaz combustibles ou de l'aluminium peut comporter des risques d'explosion.

- Ne PAS procéder à une coupe sous l'eau avec des gaz combustibles contenant de l'hydrogène.
- Ne PAS couper d'alliages d'aluminium sous l'eau ou sur une table à eau, à moins de pouvoir éviter une accumulation d'hydrogène.

Cela pourrait causer une explosion pendant le fonctionnement du système de coupe. Consulter le *Safety and Compliance Manual (Manuel de sécurité et de conformité)* (80669C) pour en savoir plus.

⚠ AVERTISSEMENT

RISQUE D'EXPLOSION – COUPE AVEC DES GAZ INFLAMMABLES OU OXYDANTS

Ne pas utiliser de gaz inflammables ou oxydants avec les systèmes Powermax. Ces gaz peuvent créer des conditions d'explosion lors des activités de coupage plasma.

L'oxygène est un exemple de gaz oxydant. L'acétylène, le propylène, le méthane et l'hydrogène pur sont des exemples de gaz inflammables. Consulter le *Safety and Compliance Manual (Manuel de conformité et de sécurité)* (80669C) pour en savoir plus.

Pour obtenir de plus amples renseignements

- Pour en savoir plus sur l'intégration du système Powermax® dans une configuration de coupe mécanique, se reporter au *Powermax65/85/105 SYNC Mechanized Cutting Guide (Guide de la coupe mécanique Powermax65/85/105 SYNC)* (810480).
- Pour obtenir des renseignements supplémentaires sur votre système, reportez-vous au *Powermax65/85/105 SYNC Operator Manual (Manuel de l'opérateur du Powermax65/85/105 SYNC)* (810470).

📄 Téléchargez ces documents au www.hypertherm.com/docs.

À propos des tableaux de coupe

Les tableaux de coupe de ce guide représentent un bon point de départ. Adaptez les variables des tableaux de coupe au besoin pour obtenir des résultats optimaux relativement à votre équipement et à votre environnement de coupe.

Des tableaux de coupe sont inclus pour ce qui suit :

- La coupe d'acier doux, d'acier inoxydable et d'aluminium de 45 A à 105 A avec de l'air à l'aide de cartouches de coupe standard
- La coupe d'acier doux et d'acier inoxydable avec de l'air à l'aide de cartouches FineCut

📄 Hypertherm a recueilli les données des tableaux de coupe en utilisant de nouvelles cartouches et en respectant toutes les exigences en matière d'alimentation en électricité et en gaz ainsi que les conditions du site.

Sélectionner la cartouche qui convient le mieux compte tenu du matériau à couper

Cartouche	Épaisseur du matériau (mm)											
	0,5	1	2	3	5	8	10	12	15	20	25	30
FineCut	■	■	■	■	■	■	■	■	■	■	■	■
45 A	■	■	■	■	■	■	■	■	■	■	■	■
65 A			■	■	■	■	■	■	■	■	■	■
85 A				■	■	■	■	■	■	■	■	■
105 A					■	■	■	■	■	■	■	■

Qualité de coupe optimale
Qualité de coupe quasi optimale
Qualité de coupe ou vitesse réduite

Cartouche	Épaisseur du matériau (po)										
	0.02	0.06	1/8	1/4	3/8	1/2	5/8	3/4	1	1 1/4	1 1/2
FineCut	■	■	■	■	■	■	■	■	■	■	■
45 A	■	■	■	■	■	■	■	■	■	■	■
65 A			■	■	■	■	■	■	■	■	■
85 A				■	■	■	■	■	■	■	■
105 A					■	■	■	■	■	■	■

Éléments des tableaux de coupe

L'illustration suivante indique les éléments qui se trouvent dans chaque tableau de coupe.

1

Mild Steel – 105 A – Air



428895 ohmic sensing ring



428936

2 Metric

Material Thickness	Cut Height	Initial Pierce Height	Pierce Delay	Best Quality		Highest Production		Kerf Width	
				Cut Speed	Arc Voltage	Cut Speed	Arc Voltage		
mm	mm	mm	%	seconds	mm/min	volts	mm/min	volts	mm
6	3.2	6.4	200	0.5	3960	143	4880	143	2.2
20				1.0	790	153	940	152	2.8
40				Edge start	200	172	250	170	5.1

2 English

Material Thickness	Cut Height	Initial Pierce Height	Pierce Delay	Best Quality		Highest Production		Kerf Width	
				Cut Speed	Arc Voltage	Cut Speed	Arc Voltage		
inches	inches	inches	%	seconds	in/min	volts	in/min	volts	inches
1/4	0.125	0.25	200	0.5	156	143	192	143	0.086
3/4				1.0	33	152	40	151	0.108
1-1/2				Edge start	9	170	10	168	0.183

4 Gas flow rate – slpm / scfh

236 / 500	Hot (cutflow)
311 / 660	Cold (postflow)

1

Type de métal :

- Acier doux
- Acier inoxydable
- Aluminium

Procédé de coupe :

- **A** = Intensité de courant. L'intensité de courant s'applique à tous les réglages fournis sur cette page.
- Dans les tableaux **FineCut**, l'intensité de courant pour chaque épaisseur est incluse dans le tableau de coupe. Ce guide comprend les tableaux pour les vitesses élevées et les vitesses réduites. Les réglages de vitesses élevées peuvent produire des coupes de meilleure qualité et moins de scories à certaines épaisseurs, si la table de coupe permet de couper à ces réglages.

Type de gaz :

- Air (ou azote)

Utiliser une **bague de détection ohmique** afin de connecter une cartouche mécanisée à un système de dispositif de réglage en hauteur de la torche (THC). L'installer sur la cartouche comme illustré. Le kit 428895 comprend trois bagues de détection ohmique (420580).

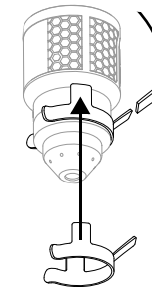

2

Metric = Mesures métriques

English = Mesures impériales

Material Thickness = Épaisseur de la pièce à couper (la plaque de métal à couper).

Cut Height = Distance entre l'extrémité de la cartouche et la pièce à couper durant la coupe.

Initial Pierce Height = Distance entre l'extrémité de la cartouche et la pièce à couper lorsque la torche est activée, avant de descendre à la hauteur de coupe.

Pierce Delay = Temps durant lequel l'arc plasma demeure stationnaire à la hauteur de perçage pendant qu'il coupe la pièce à couper.

Best Quality (Cut Speed et Arc Voltage*) = Réglages qui constituent le point de départ permettant d'obtenir une coupe de la meilleure qualité possible (meilleur angle, minimum de bavures, meilleur fini de la surface de coupe). Ajuster la vitesse en fonction de l'application et du système de coupe pour obtenir le résultat désiré.

Highest Production (Cut Speed et Arc Voltage*) = Réglages augmentant les vitesses de coupe de 20 % à 30 %. Ces vitesses donnent un plus grand nombre de pièces coupées sans qu'elles soient nécessairement de la meilleure qualité possible.

Kerf Width = Largeur de matériau enlevé par le procédé de coupe. Les largeurs de saignées sont indiquées à titre de référence uniquement. Hypertherm les a obtenues avec les réglages « Best quality (meilleure qualité) ». Les résultats réels peuvent différer de ceux indiqués dans les tableaux en raison de différences inhérentes aux installations et à la composition des matériaux.

* Pour obtenir des renseignements sur la manière d'utiliser la tension de l'arc pour contrôler la hauteur de coupe, consulter le *Powermax65/85/105 SYNC Mechanized Cutting Guide (Guide de la coupe mécanique du Powermax65/85/105 SYNC)* (810480).

3

Unités de mesure :

- mm = millimètres
- % = pourcentage
- seconds = secondes
- mm/min = millimètres par minute
- volts = volts
- inches = pouces
- in/min = pouces par minute
- A = intensité (tableaux FineCut)

Edge start = Amorçage de la coupe à partir du bord de la pièce à couper.

4

Chaque tableau de coupe indique les débits de gaz chaud et froid.

- slpm = litres standard par minute
- scfh = pieds cube standard par heure

Hot (cutflow) = L'arc plasma est activé et le débit de gaz est stable pendant la coupe.

Cold (postflow) = L'arc plasma est désactivé et le débit de gaz est stable pendant plusieurs secondes une fois la coupe terminée. Ce débit s'applique également au mode de test des gaz.

Verwendung der Schneidtabellen (Deutsch/German)

⚠️ WARNUNG

EXPLOSIONSGEFAHR – SCHNEIDEN MIT ALUMINIUM IN DER NÄHE VON WASSER

Beim Unterwasserschneiden mit Brenngasen oder Aluminium besteht u. U. Explosionsgefahr.

- NICHT unter Wasser mit Brenngasen schneiden, die Wasserstoff enthalten.
- Schneiden Sie Aluminiumlegierungen NUR DANN unter Wasser oder auf einem Wassertisch, wenn Sie die Ansammlung von Wasserstoffgas verhindern können.

Andernfalls kann dies beim Schneidbetrieb des Geräts zu einer Explosion führen. Weitere Informationen finden Sie im *Safety and Compliance Manual (Handbuch für Sicherheit und Übereinstimmung)* (80669C).

⚠️ WARNUNG

EXPLOSIONSGEFAHR – UNTERWASSERSCHNEIDEN MIT BRENNBAREN ODER OXIDIERENDEN GASEN

Verwenden Sie keine brennbaren oder oxidierenden Gase mit Powermax-Geräten. Diese Gase können zu explosiven Bedingungen während des Plasmaschneidens führen.

Ein Beispiel für ein oxidierendes Gas ist Sauerstoff. Beispiele brennbarer Gase sind Acetylen, Propylen, Methan und reiner Wasserstoff. Weitere Informationen finden Sie im *Safety and Compliance Manual (Handbuch für Sicherheit und Übereinstimmung)* (80669C).

Weiterführende Informationen

- Weitere Informationen zur Integration Ihres Powermax®-Geräts in eine mechanisierte Schneidkonfiguration finden Sie in der *Powermax65/85/105 SYNC Mechanized Cutting Guide (Powermax65/85/105 SYNC Anleitung Mechanisiertes Schneiden)* (810480).
- Weitere Informationen zu Ihrem System finden Sie in der *Powermax65/85/105 SYNC Operator Manual (Powermax65/85/105 SYNC Betriebsanleitung)* (810470).

 Sie können diese Dokumente hier downloaden www.hypertherm.com/docs.

Über die Schneidtabellen

Die Schneidtabellen in dieser Anleitung sollen als Richtwert dienen. Die Variablen in den Schneidtabellen können bedarfsgemäß angepasst werden, um optimale Ergebnisse für das Schneidgerät und die Schneidumgebung zu erzielen.

Es gibt Schneidtabellen für Folgendes:

- Schneiden von unlegiertem Stahl, legiertem Stahl und Aluminium mit 45–105 A, Luft und standardmäßigen Schneidkartuschen
- Schneiden von unlegiertem Stahl und legiertem Stahl mit Luft und FineCut-Kartuschen

 Hypertherm hat diese Schneidtabellendaten mit neuen Kartuschen ermittelt und alle Anforderungen hinsichtlich Stromversorgung, Gasversorgung und Standortbedingungen eingehalten.

Wählen Sie den besten Einsatz für das Material aus, das Sie schneiden wollen

	Materialstärke (mm)											
	0,5	1	2	3	5	8	10	12	15	20	25	30
FineCut	■	■	■	■	■							
45 A	■	■	■	■	■							
65 A			■	■	■	■	■	■	■	■	■	■
85 A				■	■	■	■	■	■	■	■	■
105 A						■	■	■	■	■	■	■

Optimale Schnittqualität
Nahezu optimale Schnittqualität
Geringere Schnittqualität oder Geschwindigkeit

	Materialstärke (Zoll)										
	0.02	0.06	1/8	1/4	3/8	1/2	5/8	3/4	1	1-1/4	1-1/2
FineCut	■	■	■								
45 A	■	■	■	■							
65 A		■	■	■	■	■	■	■	■	■	■
85 A			■	■	■	■	■	■	■	■	■
105 A				■	■	■	■	■	■	■	■

Schneidtabellen-Elemente

Die folgende Abbildung zeigt die Elemente, die sich in jeder Schneidtablelle befinden.

1

Mild Steel – 105 A – Air



428895 ohmic sensing ring



428936

2 Metric

Material Thickness	Cut Height	Initial		Pierce Delay	Best Quality		Highest Production		Kerf Width
		Pierce Height	%		Cut Speed	Arc Voltage	Cut Speed	Arc Voltage	
mm	mm	mm	%	seconds	mm/min	volts	mm/min	volts	mm
6	3.2	6.4	200	0.5	3960	143	4880	143	2.2
20				1.0	790	153	940	152	2.8
40				Edge start		200	172	250	170

2 English

Material Thickness	Cut Height	Initial		Pierce Delay	Best Quality		Highest Production		Kerf Width
		Pierce Height	%		Cut Speed	Arc Voltage	Cut Speed	Arc Voltage	
inches	inches	inches	%	seconds	in/min	volts	in/min	volts	inches
1/4	0.125	0.25	200	0.5	156	143	192	143	0.086
3/4				1.0	33	152	40	151	0.108
1-1/2				Edge start		9	170	10	168

4 Gas flow rate – slpm / scfh

236 / 500	Hot (cutflow)
311 / 660	Cold (postflow)

1

Metallart:

- Unlegierter Stahl
- Legierter Stahl
- Aluminium

Schneidverfahren:

- A = Stromstärke. Die Stromstärkeeinstellung gilt für alle Einstellungen auf dieser Seite.
- Bei den Angaben für **FineCut** ist die Stromstärkeeinstellung für jede Stärke in der Schneidtablette enthalten. Dieser Leitfaden enthält Tabellen für hohe und niedrige Geschwindigkeiten. Einstellungen mit hoher Geschwindigkeit können bei manchen Stärken eine bessere Schnittqualität und eine geringere Bartbildung erzielen, wenn das Schneiden mit diesen Einstellungen mit dem Schneidtablett möglich ist.

Gasart:

- Luft (oder Stickstoff)

Verwenden Sie einen **ohmschen Sensorring**, um einen mechanisierten Einsatz an eine Brennerhöhensteuerung (THC) anzuschließen. Montieren Sie den Einsatz wie in der Abbildung gezeigt. Das Set 428895 enthält 3 ohmsche Sensorringe (420580).

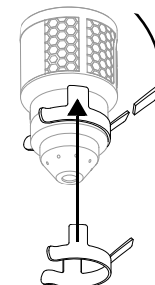

2

Metric = Metrische Maße

English = Englische Maße

Material Thickness = Stärke des Werkstücks (der zu schneidenden Metallplatte).

Cut Height = Abstand zwischen der Spitze der Kartusche und dem Werkstück während des Schneidens.

Initial Pierce Height = Abstand zwischen der Spitze der Kartusche und dem Werkstück, wenn der Brenner gezündet wird, bevor er auf die Schneidhöhe abgesenkt wird.

Pierce Delay = Verweildauer des Plasmalichtbogens auf der Lochstehhöhe, bevor er das Werkstück durchschneidet.

Best Quality (Cut Speed und Arc Voltage*) = Einstellungen, die den Anfangspunkt für die beste Schnittqualität (bester Winkel und beste Oberflächenschnittgüte bei gleichzeitig der geringsten Bartbildung) liefern. Zur Erzielung des gewünschten Ergebnisses müssen Sie die Geschwindigkeit für Ihre Anwendung und Ihre Schneidanlage anpassen.

Highest Production (Cut Speed und Arc Voltage*) = Einstellungen, die die Schnittgeschwindigkeit um 20–30 % erhöhen. Diese Geschwindigkeiten führen zwar zur größten Anzahl von Schneidteilen, aber nicht unbedingt mit der besten Schnittqualität.

Kerf Width = Breite des Zwischenraums, der durch das Entfernen von Material durch den Schneidprozess entsteht. Die Schnittfugen-Breiten dienen als Bezugswerte. Hypertherm hat sie mit den „Best Quality (Qualitätsoptimierungs)“-Einstellungen erhalten. Unterschiede bei den Installationen und in der Materialzusammensetzung können dazu führen, dass die tatsächlichen Ergebnisse von den in den Tabellen gezeigten Werten abweichen.

* Weitere Informationen zur Verwendung der Lichtbogen-Spannung zur Steuerung der Schneidhöhe finden Sie in der Powermax65/85/105 SYNC Mechanized Cutting Guide (Powermax65/85/105 SYNC Anleitung Mechanisiertes Schneiden) (810480).

3

Maßeinheiten:

- mm = Millimeter
- % = Prozentwert
- seconds = Sekunden
- mm/min = Millimeter pro Minute
- volts = Volt
- inches = Zoll
- in/min = Zoll pro Minute
- A = Stromstärke (FineCut-Tabellen)

Edge start = Startet den Schnitt an der Kante des Werkstücks.

4

In jeder Schneidtablette sind die Durchflussmengen für heiße und kalte Gase angegeben.

- slpm = Standard Liter pro Minute
- scfh = Standardkubikfuß pro Stunde

Hot (cutflow) = Der Plasmalichtbogen ist eingeschaltet, und während des Schneidvorgangs fließt ein konstanter Gasstrom.

Cold (postflow) = Der Plasmalichtbogen ist ausgeschaltet, und nachdem der Schneidvorgang abgeschlossen ist, fließt einige Sekunden lang ein konstanter Gasstrom. Diese Durchflussmenge gilt auch für den Gastestmodus.

Menggunakan Bagan Pemotongan (Bahasa Indonesia/Indonesian)

PERINGATAN



BAHAYA LEDAKAN – MEMOTONG DENGAN ALUMINIUM DI DEKAT AIR

Pemotongan di dalam air dengan gas bahan bakar atau aluminium dapat menimbulkan bahaya ledakan.

- JANGAN memotong di dalam air dengan gas bahan bakar yang mengandung hidrogen.
- JANGAN memotong logam campuran aluminium di dalam air atau di atas meja air, kecuali jika Anda dapat mencegah akumulasi gas hidrogen.

Melakukan hal tersebut dapat menyebabkan ledakan selama pengoperasian sistem pemotongan. Silakan merujuk *Safety and Compliance Manual (Petunjuk Keselamatan dan Kepatuhan)* (80669C) untuk informasi selengkapnya.

PERINGATAN



BAHAYA LEDAKAN – MEMOTONG DENGAN GAS MUDAH TERBAKAR ATAU BEROKSIDASI

Jangan menggunakan gas mudah terbakar atau beroksidasi dalam sistem Powermax. Gas jenis ini dapat menyebabkan kondisi mudah meledak selama pengoperasian pemotongan plasma.

Contoh dari gas yang beroksidasi adalah oksigen. Contoh gas-gas yang mudah terbakar adalah asetilena, propilena, metana, dan hidrogen murni. Silakan merujuk pada *Safety and Compliance Manual (Petunjuk Keselamatan dan Kepatuhan)* (80669C) untuk informasi selengkapnya.

Untuk informasi selengkapnya

- Untuk memperoleh informasi tentang cara memadukan sistem Powermax® Anda dengan setelan pemotongan mekanis, harap merujuk *Powermax65/85/105 SYNC Mechanized Cutting Guide (Panduan Pemotongan Mekanis Powermax65/85/105 SYNC)* (810480).
- Untuk informasi selanjutnya tentang sistem yang Anda miliki, harap merujuk *Powermax65/85/105 SYNC Operator Manual (Powermax65/85/105 SYNC Manual untuk Operator)* (810470).

Silakan unduh dokumennya di www.hypertherm.com/docs.

Tentang bagan pemotongan

Bagan pemotongan dalam panduan ini merupakan permulaan yang baik. Sesuaikan variabel dalam bagan pemotongan sebagaimana diperlukan untuk mendapat hasil yang optimal untuk peralatan dan lingkungan pemotongan Anda.

Bagan pemotongan digunakan untuk kondisi berikut ini:

- Memotong baja lunak, baja nirkarat, dan aluminium pada 45 A – 105 A dengan menggunakan udara dan kartrij potongan standar
- Memotong baja lunak dan baja nirkarat dengan menggunakan udara dan kartrid FineCut

Hypertherm mengumpulkan data bagan pemotongan menggunakan kartrid baru dan mematuhi semua persyaratan untuk pasokan listrik, pasokan gas, dan kondisi pabrik.

Pilih kartrid terbaik untuk material yang akan Anda potong

Kartrid	Ketebalan bahan menurut sistem metrik (mm)											
	0,5	1	2	3	5	8	10	12	15	20	25	30
FineCut	■	■	■	■	■							
45 A	■	■	■	■	■							
65 A			■	■	■	■	■	■	■	■	■	■
85 A				■	■	■	■	■	■	■	■	■
105 A						■	■	■	■	■	■	■

Kualitas pemotongan yang optimal
Kualitas pemotongan yang mendekati optimal
Kualitas atau kecepatan pemotongan yang diturunkan

Kartrid	Ketebalan bahan menurut sistem Inggris (inci)										
	0.02	0.06	1/8	1/4	3/8	1/2	5/8	3/4	1	1-1/4	1-1/2
FineCut	■	■	■								
45 A	■	■	■	■							
65 A			■	■	■	■	■	■	■	■	■
85 A				■	■	■	■	■	■	■	■
105 A					■	■	■	■	■	■	■

Bagian-bagian pada bagan pemotongan

Ilustrasi berikut ini menjelaskan bagian apa saja yang ada pada setiap bagan pemotongan.

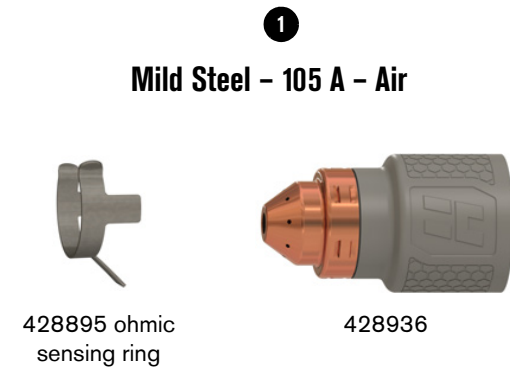

2 Metric

Material Thickness	Cut Height	Initial Pierce Height		Pierce Delay	Best Quality		Highest Production		Kerf Width
		mm	%		seconds	Cut Speed	Arc Voltage	Cut Speed	
6	3.2	6.4	200	0.5	3960	143	4880	143	2.2
20				1.0	790	153	940	152	2.8
40				Edge start	200	172	250	170	5.1

2 English

Material Thickness	Cut Height	Initial Pierce Height		Pierce Delay	Best Quality		Highest Production		Kerf Width
		inches	%		seconds	in/min	volts	in/min	
1/4	0.125	0.25	200	0.5	156	143	192	143	0.086
3/4				1.0	33	152	40	151	0.108
1-1/2				Edge start	9	170	10	168	0.183

4 Gas flow rate – slpm / scfh

236 / 500	Hot (cutflow)
311 / 660	Cold (postflow)

- 1** Jenis logam:
- Baja Lunak
 - Baja Nirkarat
 - Aluminium

Proses pemotongan:

- **A** = Kuat Arus dalam Ampere. Kuat arus dalam ampere ini berlaku untuk semua pengaturan pada halaman tersebut.
- Dalam bagan **FineCut**, kuat arus untuk setiap ketebalan disertakan dalam bagan pemotongan. Pedoman ini meliputi bagan untuk kecepatan tinggi dan kecepatan rendah. Pengaturan untuk kecepatan tinggi dapat menghasilkan kualitas pemotongan yang lebih baik dan terak yang lebih sedikit pada sejumlah ketebalan, jika meja pemotongan dapat digunakan sesuai pengaturan tersebut.

Jenis gas:

- Udara (atau nitrogen)

Gunakan **cincin sensor ohmik** untuk menyambung kartrid mekanis ke kendali ketinggian kepala las/torch height control (THC). Pasang cincin tersebut di kartrid seperti ditampilkan. Kit 428895 meliputi 3 cincin sensor ohmik (420580).

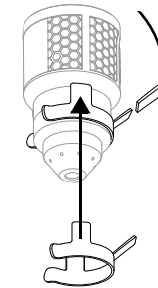

- 2 Metric** = Ukuran dalam satuan metrik

English = Ukuran dalam satuan Inggris

Material Thickness = Ketebalan bahan (pelat metal yang akan dipotong)

Cut Height = Jarak antara ujung kartrid dengan bahan yang dipotong selama pemotongan.

Initial Pierce Height = Jarak antara ujung kartrid dengan bahan yang dipotong saat kepala las dinyalakan, sebelum diturunkan ke ketinggian pemotongan.

Pierce Delay = Lamanya busur plasma berada di ketinggian penembusan tanpa digerakkan sementara memotong tembus bahan.

Best Quality (Cut Speed dan Arc Voltage*) = Pengaturan yang menghasilkan titik permulaan untuk kualitas pemotongan terbaik (sudut terbaik, limbah paling sedikit, hasil permukaan potongan terbaik). Sesuaikan kecepatan untuk aplikasi dan sistem pemotongan Anda agar mencapai hasil yang diinginkan.

Highest Production (Cut Speed dan Arc Voltage*) = Pengaturan yang dapat meningkatkan kecepatan pemotongan sebesar 20% – 30%. Kecepatan semacam ini menghasilkan lebih banyak potongan, namun kualitasnya mungkin bukan yang terbaik.

Kerf Width = Lebar bahan yang disingkirkan melalui proses pemotongan. Lebar goresan (kerf width) hanya digunakan sebagai referensi. Hypertherm mampu menghasilkannya dengan menggunakan pengaturan "Best Quality (Kualitas Terbaik)". Perbedaan antara pemasangan dan komposisi bahan dapat menimbulkan hasil riil yang berbeda dari yang ditampilkan di tabel.

* Untuk mendapatkan informasi tentang cara menggunakan tegangan busur untuk mengontrol ketinggian pemotongan, harap merujuk *Powermax65/85/105 SYNC Mechanized Cutting Guide (Powermax65/85/105 SYNC Panduan Pemotongan Mekanik)* (810480).

- 3** Satuan ukuran:
- **mm** = milimeter
 - **%** = persentase
 - **seconds** = detik
 - **mm/min** = milimeter per menit
 - **volts** = volt
 - **inches** = inci
 - **in/min** = inci/menit
 - **A** = Kuat Arus dalam Ampere (tabel FineCut)

Edge start = Memulai pemotongan dari ujung bahan yang akan dipotong.

- 4** Setiap bagan pemotongan menampilkan kecepatan aliran gas panas dan dingin.

- **slpm** = Liter per menit standar
- **scfh** = Kaki kubik per jam standar

Hot (cutflow) = Busur plasma menyala, dan terdapat aliran gas yang konsisten saat melakukan pemotongan.

Cold (postflow) = Busur plasma mati, dan terdapat aliran gas yang konsisten selama beberapa detik setelah pemotongan selesai. Kecepatan aliran ini juga berlaku untuk mode pengujian gas.

⚠ AVVERTENZA



PERICOLO DI ESPLOSIONE – TAGLIO CON ALLUMINIO IN PROSSIMITÀ DELL'ACQUA

Il taglio subacqueo con gas combustibili o alluminio può creare un pericolo di esplosione.

- NON effettuare tagli subacquei con gas combustibili che contengono idrogeno.
- NON eseguire il taglio subacqueo o su tavolo ad acqua di leghe di alluminio a meno che non si possa prevenire l'accumulo di idrogeno.

Ciò potrebbe causare un'esplosione durante il funzionamento del sistema di taglio. Per ulteriori informazioni, fare riferimento al *Safety and Compliance Manual (Manuale sulla sicurezza e la conformità)* (80669C).

⚠ AVVERTENZA



PERICOLO DI ESPLOSIONE – TAGLIO CON GAS COMBUSTIBILI OD OSSIDANTI

Non utilizzare gas infiammabili od ossidanti con sistemi Powermax. Questi gas possono comportare condizioni esplosive durante le operazioni di taglio plasma.

Un esempio di gas ossidante è l'ossigeno. Esempi di gas infiammabili sono acetilene, propilene, metano e idrogeno puro. Per ulteriori informazioni, fare riferimento al *Safety and Compliance Manual (Manuale di sicurezza e conformità)* (80669C).

Per ulteriori informazioni

- Per informazioni sull'integrazione del sistema Powermax® in uso con una configurazione di taglio automatizzato, vedere la *Powermax65/85/105 SYNC Mechanized Cutting Guide (Guida al taglio meccanizzato Powermax65/85/105 SYNC)* (810480).
- Per informazioni sull'integrazione del sistema Powermax® in uso con una configurazione di taglio automatizzato, vedere la *Powermax65/85/105 SYNC Mechanized Cutting Guide (Guida al taglio meccanizzato Powermax65/85/105 SYNC)* (810480).



Scaricare questi documenti all'indirizzo www.hypertherm.com/docs.

Informazioni sulle tabelle di taglio

Le tabelle di taglio in questa guida servono a fornire un buon punto di partenza. Adattare le variabili nelle tabelle di taglio in base alle esigenze per ottenere risultati ottimali per l'ambiente e le apparecchiature da taglio.

Sono incluse tabelle di taglio per:

- Taglio di acciaio al carbonio, acciaio inox e alluminio a 45 A – 105 A con aria utilizzando cartucce di taglio standard
- Taglio di acciaio al carbonio e acciaio inox con aria utilizzando cartucce FineCut



Hypertherm ha raccolto i dati della tabella di taglio utilizzando nuove cartucce e rispettando tutti i requisiti per l'alimentazione elettrica, l'alimentazione del gas e le condizioni del sito.

Selezionare la cartuccia più appropriata per il materiale che si desidera tagliare

	Spessore del materiale (mm)											
	0,5	1	2	3	5	8	10	12	15	20	25	30
FineCut	Black	Black	Black	Black	Black	Black	Black	Black	Black	Black	Black	Black
45 A	Black	Black	Black	Black	Black	Black	Black	Black	Black	Black	Black	Black
65 A	Black	Black	Black	Black	Black	Black	Black	Black	Black	Black	Black	Black
85 A	Black	Black	Black	Black	Black	Black	Black	Black	Black	Black	Black	Black
105 A	Black	Black	Black	Black	Black	Black	Black	Black	Black	Black	Black	Black

Qualità di taglio ottimale

Qualità di taglio quasi ottimale

Qualità o velocità di taglio ridotta

	Spessore del materiale (pollici)										
	0.02	0.06	1/8	1/4	3/8	1/2	5/8	3/4	1	1-1/4	1-1/2
FineCut	Black	Black	Black	Black	Black	Black	Black	Black	Black	Black	Black
45 A	Black	Black	Black	Black	Black	Black	Black	Black	Black	Black	Black
65 A	Black	Black	Black	Black	Black	Black	Black	Black	Black	Black	Black
85 A	Black	Black	Black	Black	Black	Black	Black	Black	Black	Black	Black
105 A	Black	Black	Black	Black	Black	Black	Black	Black	Black	Black	Black

Elementi della tabella di taglio

La seguente illustrazione identifica gli elementi che si trovano su ciascuna tabella di taglio.

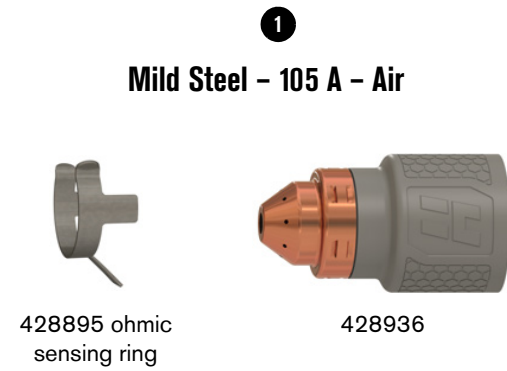

2 Metric

Material Thickness	Cut Height	Initial Pierce Height	Pierce Delay	Best Quality		Highest Production		Kerf Width	
				Cut Speed	Arc Voltage	Cut Speed	Arc Voltage		
mm	mm	mm	%	seconds	mm/min	volts	mm/min	volts	mm
6	3.2	6.4	200	0.5	3960	143	4880	143	2.2
20				1.0	790	153	940	152	2.8
40				Edge start		200	172	250	170

2 English

Material Thickness	Cut Height	Initial Pierce Height	Pierce Delay	Best Quality		Highest Production		Kerf Width	
				Cut Speed	Arc Voltage	Cut Speed	Arc Voltage		
inches	inches	inches	%	seconds	in/min	volts	in/min	volts	inches
1/4	0.125	0.25	200	0.5	156	143	192	143	0.086
3/4				1.0	33	152	40	151	0.108
1-1/2				Edge start		9	170	10	168

4 Gas flow rate – slpm / scfh

236 / 500	Hot (cutflow)
311 / 660	Cold (postflow)

1 Tipo di metallo:

- Acciaio al carbonio
- Acciaio inox
- Alluminio

Processo di taglio:

- **A** = Amperaggio. L'amperaggio si applica a tutte le impostazioni indicate in quella pagina.
- Nelle tabelle **FineCut**, l'amperaggio per ciascuno spessore è incluso nella tabella di taglio. Questa guida include tabelle di velocità elevata e velocità ridotta. Le impostazioni di velocità elevata possono offrire una qualità di taglio migliore e meno bava ad alcuni spessori, se la tabella di taglio consente di tagliare utilizzando quelle impostazioni.

Tipo di gas:

- **Aria** (o azoto)

Utilizzare un **anello di rilevamento ohmico** per collegare una cartuccia meccanizzata a un sistema di controllo di altezza torcia (THC). Installarlo sulla cartuccia come mostrato. Il kit 428895 include 3 anelli di rilevamento ohmico (420580).

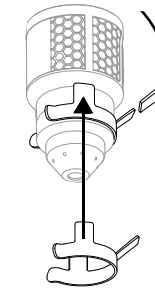

2 Metric = Misurazioni con il sistema metrico

English = Misurazioni con il sistema imperiale

Material Thickness = Spessore del pezzo in lavorazione (la piastra di metallo da tagliare).

Cut Height = Distanza tra la punta della cartuccia e il pezzo in lavorazione durante il taglio.

Initial Pierce Height = Distanza tra la punta della cartuccia e il pezzo in lavorazione quando la torcia è attivata, prima di scendere all'altezza di taglio.

Pierce Delay = Periodo di tempo in cui l'arco plasma rimane fermo all'altezza di sfondamento mentre taglia il pezzo in lavorazione.

Best Quality (Cut Speed e Arc Voltage*) = Impostazioni che forniscono il punto di partenza per identificare la migliore qualità di taglio (migliore angolo, meno bava, migliore finitura di taglio superficie). Regolare la velocità dell'applicazione e del sistema di taglio per ottenere il risultato desiderato.

Highest Production (Cut Speed e Arc Voltage*) = Impostazioni che aumentano le velocità di taglio del 20% – 30%. Queste velocità offrono il maggior numero di pezzi tagliati, ma non necessariamente la migliore qualità di taglio.

Kerf Width = Larghezza del materiale rimosso dal processo di taglio. Le larghezze kerf servono solo come riferimento. Hypertherm le ha ottenute utilizzando le impostazioni di "Best Quality (migliore qualità)". A causa delle differenze tra le varie installazioni e della diversa composizione dei materiali, i valori ottenuti possono variare rispetto a quelli riportati nelle tabelle.

* Per informazioni su come usare la tensione d'arco per controllare l'altezza di taglio, vedere la *Powermax65/85/105 SYNC Mechanized Cutting Guide (Guida al taglio meccanizzato Powermax65/85/105 SYNC)* (810480).

3 Unità di misura:

- **mm** = millimetri
- **%** = percentuale
- **seconds** = secondi
- **mm/min** = millimetri al minuto
- **volts** = volt
- **inches** = pollici
- **in/min** = pollici al minuto
- **A** = amperaggio (tabelle FineCut)

Edge start = Iniziare il taglio partendo dal bordo del pezzo in lavorazione.

4 Ogni tabella di taglio elenca le portate (di flusso) di gas caldo e freddo.

- **slpm** = litro standard al minuto
- **scfh** = piedi cubi standard all'ora

Hot (cutflow) = L'arco plasma è attivato e durante il taglio c'è un flusso costante di gas.

Cold (postflow) = L'arco plasma è disattivato e al termine del taglio c'è un flusso costante di gas per diversi secondi. Questa portata di flusso si applica anche per la modalità di verifica gas.

切断条件表の使用方法 [日本語 / Japanese]

警告



爆発の危険 – アルミの切断は水の近くで行わないこと

燃料ガスを使った水中切断やアルミの水中切断は爆発の危険性があります。

- 水素を含む燃料ガスは水中切断に使用しないでください。
- 水素ガスの滞留を防止できる場合を除き、プラズマトーチを使ってアルミ合金を水中やウォーターテーブル上で切断しないでください。

そのような切断は、切断システムの操作中に爆発を引き起こす可能性があります。詳細については、*Safety and Compliance Manual* 「安全とコンプライアンスマニュアル」(80669C) をお読みください。

警告



爆発の危険 – 可燃性ガスまたは酸化ガスを使用して切断しないこと

可燃性ガスや酸化ガスを Powermax システムで使用しないでください。このようなガスは、プラズマ切断操作中に爆発の危険性のある状態をもたらすことがあります。

酸化ガスの例は酸素です。可燃性ガスの例としては、アセチレン、プロピレン、メタン、および純水素が挙げられます。詳細については、*Safety and Compliance Manual* 「安全とコンプライアンスマニュアル」(80669C) をお読みください。

詳細について

- Powermax® システムと自動切断設定との統合に関する詳細については、*Powermax65/85/105 SYNC Mechanized Cutting Guide* 「Powermax65/85/105 SYNC 機械式切断ガイド」(810480) をご覧ください。
- お使いのシステムの詳細については、*Powermax65/85/105 SYNC Operator Manual* 「Powermax65/85/105 SYNC 取扱説明書」(810470) をご覧ください。

これらのドキュメントは www.hypertherm.com/docs からダウンロード可能です。

切断条件表について

このガイドの切断条件表は出発点としてご利用いただけます。お使いの切断装置と環境で最適な結果が得られるように、必要に応じて切断条件表の変数を調整してください。

切断条件表は以下を対象としています。

- 軟鋼、ステンレス、アルミを 45 A ~ 105 A で標準切断カートリッジを使用してエアで切断する
- 軟鋼とステンレスを FineCut カートリッジを使用してエアで切断する

Hypertherm は新しいカートリッジを使用して、電力供給、ガス供給、および設置場所の条件に関するすべての要件を満たした状態で切断条件表のデータを収集しました。

切断したい材料に対して最適なカートリッジを選択します。

メートル法 材料厚 (mm)	メートル法 材料厚 (mm)											
	0.5	1	2	3	5	8	10	12	15	20	25	30
FineCut	■	■	■	■	■							
45 A	■	■	■	■	■	■	■	■	■	■	■	■
65 A			■	■	■	■	■	■	■	■	■	■
85 A				■	■	■	■	■	■	■	■	■
105 A					■	■	■	■	■	■	■	■

最適な切断品質
最適またはそれに近い
切断品質
切断品質または
速度の減少

英語 材料厚 (インチ)	英語 材料厚 (インチ)										
	0.02	0.06	1/8	1/4	3/8	1/2	5/8	3/4	1	1-1/4	1-1/2
FineCut	■	■	■	■							
45 A	■	■	■	■	■	■	■	■	■	■	■
65 A		■	■	■	■	■	■	■	■	■	■
85 A			■	■	■	■	■	■	■	■	■
105 A				■	■	■	■	■	■	■	■

切断条件表の各要素

以下の図は、各切断条件表に記載されている各要素を示しています。

1

Mild Steel – 105 A – Air



428895 ohmic sensing ring

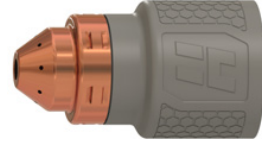

428936

2 Metric

Material Thickness	Cut Height	Initial Pierce Height	Pierce Delay	Best Quality		Highest Production		Kerf Width	
				Cut Speed	Arc Voltage	Cut Speed	Arc Voltage		
mm	mm	mm	%	seconds	mm/min	volts	mm/min	volts	mm
6	3.2	6.4	200	0.5	3960	143	4880	143	2.2
20				1.0	790	153	940	152	2.8
40				Edge start		200	172	250	170

2 English

Material Thickness	Cut Height	Initial Pierce Height	Pierce Delay	Best Quality		Highest Production		Kerf Width	
				Cut Speed	Arc Voltage	Cut Speed	Arc Voltage		
inches	inches	inches	%	seconds	in/min	volts	in/min	volts	inches
1/4	0.125	0.25	200	0.5	156	143	192	143	0.086
3/4				1.0	33	152	40	151	0.108
1-1/2				Edge start		9	170	10	168

Gas flow rate – slpm / scfh

236 / 500	Hot (cutflow)
311 / 660	Cold (postflow)

1 材料の種類:

- 軟鋼
- ステンレス
- アルミ

切断プロセス:

- **A** = アンペア数。アンペア数はその頁の全設定に適用されます。
- **FineCut** の表では、各板厚向けのアンペア数は切断条件表に含まれています。このガイドには、高速と低速のチャートが含まれます。高速設定は切断品質が高く、切断機テーブルでその設定による切断が可能であれば、ある程度の厚さを少ないドロスで切断できます。

ガスの種類:

- **エア** (または窒素)

機械式カートリッジをトーチ高さコントロール (THC) システムに取り付けるには、**オームセンシングリング**を使用します。画像のようにカートリッジを取り付けます。428895 キットにはオームセンシングリング 3 個が含まれています。

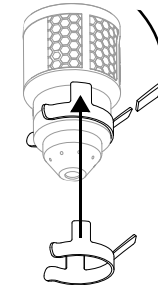

2 **Metric** = メートル法表記の測定値

English = 英国法 (インチ) 表記の測定値

Material Thickness = ワークピース (切断される金属板材) の厚さ。

Cut Height = 切断時のカートリッジの先端からワークピースまでの距離。

Initial Pierce Height = 切断高さまで下降する前にトーチが点火した時の、カートリッジの先端からワークピースまでの距離。

Pierce Delay = ワークピースを切断する間、プラズマアークがピース高さで静止している時間の長さ。

Best Quality (Cut Speed および Arc Voltage*) = 最高切断品質 (最善の角度、最小ドロス、最善の切断面仕上げ) を見つけるための出発点となる設定。希望する結果を得るには、作業内容や切断機に合わせて速度を調整してください。

Highest Production (Cut Speed および Arc Voltage*) = 切断速度を 20% ~ 30% 上げる設定。これらの速度は切断部品数を増加させますが、必ずしも最良の品質を提供するわけではありません。

Kerf Width = 切断プロセスで除去される材料の幅。カーフ幅は参考用です。Hypertherm は、「Best Quality (最高切断品質)」設定を使用してこのような結果を得ました。設備との材料構成の違いによって、実際の結果は表に示されているものとは異なる場合があります。

* アーク電圧を使用して切断高さを制御する方法に関しては、Powermax65/85/105 SYNC Mechanized Cutting Guide 「Powermax65/85/105 SYNC 機械式切断ガイド」(810480) をご覧ください。

3 測定単位:

- **mm** = ミリメートル
- **%** = パーセント
- **seconds** = 秒
- **mm/min** = ミリメートル/分
- **volts** = ボルト
- **inches** = インチ
- **in/min** = インチ/分
- **A** = アンペア数 (FineCut の表)

Edge start = ワークピース端面からの切断スタート。

4 それぞれの切断条件表は熱気および冷気のガス流量率を列挙しています。

- **slpm** = 1 分間当たりの標準リットル数
- **scfh** = 1 時間当たりの標準立方フィート数

Hot (cutflow) = プラズマアークがオンで、切断中に一定したガスの流れがあります。

Cold (postflow) = プラズマアークがオフで、切断の完了後数秒間にわたって一定したガスの流れがあります。この流量はガステストモードにも適用されます。

⚠ 경고



폭발 위험 - 물 근처에서 알루미늄으로 절단

연료 가스 또는 알루미늄을 사용한 수중 절단 시에는 폭발 위험이 생길 수 있습니다.

- 수소가 포함된 연료 가스로 수중 절단 작업을 하지 마십시오.
- 수소 가스의 축적을 막을 수 있는 경우가 아니라면 수중 또는 워터 테이블에서 알루미늄 합금을 절단하지 마십시오.

이러한 작업을 진행하면 절단 시스템 작동 시 폭발이 일어날 수 있습니다. 자세한 내용은 *Safety and Compliance Manual(안전 및 규정 준수 설명서)(80669C)*를 참조하십시오.

⚠ 경고



폭발 위험 - 절단 시 인화성 또는 산화 가스를 사용하는 경우

Powermax 시스템에 가연성 또는 산화 가스를 사용하지 마십시오. 이러한 가스들은 플라즈마 절단 작업을 수행하는 동안 폭발할 수 있는 상황을 만들 수 있습니다.

산화 가스의 한 예는 산소입니다. 가연성 가스의 종류에는 아세틸렌, 프로판, 메탄, 순수 산소가 있습니다. 자세한 내용은 *Safety and Compliance Manual(안전 및 규정 준수 설명서)(80669C)*을 참조하십시오.

자세한 정보

- Powermax® 시스템을 자동 절단 설정과 통합하는 것에 관한 자세한 정보는 *Powermax65/85/105 SYNC Mechanized Cutting Guid(Powermax65/85/105 SYNC 자동 절단 가이드)(810480)*를 참조하십시오.
- 시스템에 대한 보다 자세한 정보는 *Powermax65/85/105 SYNC Operator Manual(Powermax65/85/105 SYNC 작업자 설명서)(810470)*를 참조하십시오.

이러한 문서는 www.hypertherm.com/docs에서 다운로드하십시오.

절단 도표 정보

이 가이드의 절단 도표는 좋은 출발점입니다. 필요에 따라 절단 도표의 변수들을 조절하여 절단 장비와 환경에 맞는 최적의 결과를 얻습니다.

절단 도표는 다음을 위해 포함되어 있습니다:

- 표준 절단 카트리지를 사용하여 공기로 45A-105A에서 연강, 스테인리스강, 알루미늄을 절단
- FineCut 카트리지를 사용하여 공기로 연강과 스테인리스강을 절단
- 표준 절단 카트리지를 사용하여 F5 가스로 45A-105A에서 스테인리스강을 절단

Hypertherm은 새 카트리지와 전력 공급, 가스 공급, 현장 상황의 모든 요건을 충족하여 절단 도표 데이터를 수집했습니다.

절단하는 소재에 가장 적합한 카트리지를 선택하십시오.

절단 도표	미터식 소재 두께(mm)											
	0.5	1	2	3	5	8	10	12	15	20	25	30
FineCut	■	■	■	■	■	■	■	■	■	■	■	■
45A	■	■	■	■	■	■	■	■	■	■	■	■
65A	■	■	■	■	■	■	■	■	■	■	■	■
85A	■	■	■	■	■	■	■	■	■	■	■	■
105A	■	■	■	■	■	■	■	■	■	■	■	■

최적의 절단 품질
최적의 절단 품질에 근접
저하된 절단 품질 또는 속도

절단 도표	영국식 소재 두께(인치)										
	0.02	0.06	1/8	1/4	3/8	1/2	5/8	3/4	1	1-1/4	1-1/2
FineCut	■	■	■	■	■	■	■	■	■	■	■
45A	■	■	■	■	■	■	■	■	■	■	■
65A	■	■	■	■	■	■	■	■	■	■	■
85A	■	■	■	■	■	■	■	■	■	■	■
105A	■	■	■	■	■	■	■	■	■	■	■

절단 도표 요소

다음 그림은 각 절단 도표에 있는 요소들입니다.

1

Mild Steel - 105 A - Air



428895 ohmic sensing ring

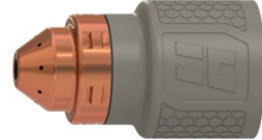

428936

2 Metric

Material Thickness	Cut Height	Initial Pierce Height	Pierce Delay	Best Quality		Highest Production		Kerf Width	
				Cut Speed	Arc Voltage	Cut Speed	Arc Voltage		
mm	mm	mm	%	seconds	mm/min	volts	mm/min	volts	mm
6	3.2	6.4	200	0.5	3960	143	4880	143	2.2
20				1.0	790	153	940	152	2.8
40				Edge start	200	172	250	170	5.1

2 English

Material Thickness	Cut Height	Initial Pierce Height	Pierce Delay	Best Quality		Highest Production		Kerf Width	
				Cut Speed	Arc Voltage	Cut Speed	Arc Voltage		
inches	inches	inches	%	seconds	in/min	volts	in/min	volts	inches
1/4	0.125	0.25	200	0.5	156	143	192	143	0.086
3/4				1.0	33	152	40	151	0.108
1-1/2				Edge start	9	170	10	168	0.183

4 Gas flow rate - slpm / scfh

236 / 500	Hot (cutflow)
311 / 660	Cold (postflow)

1 금속 종류:

- 연강
- 스테인리스 스틸
- 알루미늄

절단 작업:

- A = 암페어수. 암페어수는 해당 페이지의 모든 설정에 적용됩니다.
- FineCut 도표에서 각 두께에 대한 암페어수는 절단 도표에 포함되어 있습니다. 본 가이드에는 고속 및 저속 차트가 있습니다. 절단 테이블에서 고속 설정으로 절단하는 것이 가능하다면 고속 설정은 일부 두께에서 절단 품질을 향상시키고 드로스를 감소시킬 수 있습니다.

가스 종류:

- 공기(또는 질소)

옴 감지용 링을 사용하여 자동화 카트리지를 토치 높이 조절(THC) 시스템에 연결하십시오. 이것을 그림과 같이 카트리지에 설치하십시오. 428895 키트에는 옴 감지용 링(420580)이 3개 포함되어 있습니다.

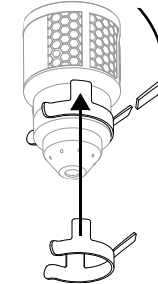

3 측정 단위:

- mm = 밀리미터
- % = 퍼센트
- seconds = 초
- mm/min = 분당 밀리미터
- volts = 볼트
- inches = 인치
- in/min = 분당 인치
- A = 암페어수(FineCut 도표)

Edge start = 가공물의 에지에서 절단 시작.

2 Metric = 미터법

English = 야드법

Material Thickness = 가공물(절단할 금속판)의 두께.

Cut Height = 절단 시 카트리지의 끝과 가공물 간의 거리.

Initial Pierce Height = 절단 높이로 내려가기 전 토치가 접화될 때 카트리지 끝과 가공물 간의 거리.

Pierce Delay = 플라즈마 아크가 가공물을 절단할 때 피어싱 높이에서 플라즈마 아크가 멈추어 있는 시간.

Best Quality(Cut Speed와 Arc Voltage*) = 최상의 절단 품질(최상의 각도, 최소 드로스, 최상의 절단 표면 마무리)을 찾기에 적절한 시작점을 제공하는 설정. 원하는 결과를 얻을 수 있도록 용도와 절단 시스템에 맞게 속도를 조정하십시오.

Highest Production(Cut Speed와 Arc Voltage*) = 절단 속도를 20%~30% 높여주는 설정. 이러한 속도는 절단 파트 수를 늘려주지만, 반드시 절단 품질이 최고인 것은 아닙니다.

Kerf Width = 절단 프로세스에서 제거된 소재의 너비. 커프 너비는 참고용입니다. Hypertherm은 "Best Quality(최고 품질)" 설정으로 이 수치를 얻었습니다. 설치와 절단물의 물질 구성비 간 차이에 따라 실제 결과가 도표에 표시된 것과 다를 수 있습니다.

* 절단 높이를 조절하기 위해 아크 전압을 사용하는 더 자세한 정보는 Powermax65/85/105 SYNC Mechanized Cutting Guide (Powermax65/85/105 SYNC 자동 절단 가이드)(810480)를 참조하십시오.

4 각 절단 도표에는 뜨거운 가스 유량과 차가운 가스 유량이 나와 있습니다.

- slpm = 분당 표준 리터
- scfh = 시간당 표준 입방 피트

Hot (cutflow) = 플라즈마 아크가 켜져 있으며, 절단 시 가스가 꾸준히 흐릅니다.

Cold (postflow) = 플라즈마 아크가 꺼져 있으며, 절단 완료 후 몇 초 동안 가스가 꾸준히 흐릅니다. 이 유량도 가스 테스트 모드에 적용됩니다.

⚠ OSTRZEŻENIE



NIEBEZPIECZEŃSTWO EKSPLOZJI – CIĘCIE ALUMINIUM W POBLIŻU WODY

Cięcie pod lustrem wody przy użyciu gazu paliwowego lub na aluminium może stworzyć zagrożenie wybuchem.

- NIE ciąć pod lustrem wody przy użyciu gazów paliwowych zawierających wodór.
- NIE ciąć stopów aluminium pod lustrem wody ani na stole wodnym, jeśli nie wdrożono rozwiązań zapobiegających gromadzeniu się wodoru.

Mogłoby to doprowadzić do wybuchu podczas pracy systemu cięcia. Więcej informacji znajduje się w dokumencie *Safety and Compliance Manual (Podręcznik bezpieczeństwa i zgodności)* (80669C).

⚠ OSTRZEŻENIE



NIEBEZPIECZEŃSTWO EKSPLOZJI – CIĘCIE Z GAZAMI PALNYMI LUB UTLENIAJĄCYMI

Z systemami Powermax nie wolno stosować gazów palnych ani utleniających. Mogą one wytworzyć warunki zagrożenia eksplozją podczas operacji cięcia plazmowego.

Przykładem gazu utleniającego jest tlen. Przykłady gazów palnych to acetylen, propylen, metan i czysty wodór. Więcej informacji znajduje się w dokumencie *Safety and Compliance Manual (Podręcznik bezpieczeństwa i zgodności)* (80669C).

Dodatkowe informacje

- Informacje na temat integracji systemu Powermax® z funkcją ustawienia cięcia zmechanizowanego można znaleźć w dokumencie *Powermax65/85/105 SYNC Mechanized Cutting Guide (Podręcznik cięcia zmechanizowanego do systemu Powermax65/85/105 SYNC)* (810480).
- Dodatkowe informacje o systemie można znaleźć w dokumencie *Powermax65/85/105 SYNC Operator Manual (Podręcznik operatora systemu Powermax65/85/105 SYNC)* (810470).



Dokumenty można pobrać pod adresem www.hypertherm.com/docs.

O wykresach cięcia

Przedstawione w tym przewodniku wykresy cięcia umożliwiają odpowiednie zaplanowanie operacji cięcia. Aby uzyskać optymalne efekty przy użyciu posiadanego sprzętu cięcia i bieżącego środowiska roboczego, przedstawione tutaj wartości można modyfikować.

Przedstawione wykresy cięcia dotyczą następujących procesów:

- Cięcie stali miękkiej, stali nierdzewnej i aluminium z natężeniem prądu 45–105 A i z powietrzem za pomocą standardowych wkładów do cięcia
- Cięcie stali miękkiej i stali nierdzewnej powietrzem za pomocą wkładów FineCut



Firma Hypertherm zgromadziła poniższe dane cięcia za pomocą nowych wkładów, spełniając wszystkie wymagania dotyczące zasilania elektrycznego, zasilania gazem i warunków w miejscu eksploatacji.

Wybierz wkład najlepiej dopasowany do ciętego materiału

	Grubość materiału w jednostkach metrycznych (mm)											
	0,5	1	2	3	5	8	10	12	15	20	25	30
FineCut	Black	Black	Black	Black	Black	Black	Black	Black	Black	Black	Black	Black
45 A	Black	Black	Black	Black	Black	Black	Black	Black	Black	Black	Black	Black
65 A	Black	Black	Black	Black	Black	Black	Black	Black	Black	Black	Black	Black
85 A	Black	Black	Black	Black	Black	Black	Black	Black	Black	Black	Black	Black
105 A	Black	Black	Black	Black	Black	Black	Black	Black	Black	Black	Black	Black

Optymalna
jakość cięcia

Jakość cięcia
zbliżona
do optymalnej

Zmniejszona
jakość lub
szybkość cięcia

	Grubość materiału w jednostkach imperialnych (cale)										
	0.02	0.06	1/8	1/4	3/8	1/2	5/8	3/4	1	1-1/4	1-1/2
FineCut	Black	Black	Black	Black	Black	Black	Black	Black	Black	Black	Black
45 A	Black	Black	Black	Black	Black	Black	Black	Black	Black	Black	Black
65 A	Black	Black	Black	Black	Black	Black	Black	Black	Black	Black	Black
85 A	Black	Black	Black	Black	Black	Black	Black	Black	Black	Black	Black
105 A	Black	Black	Black	Black	Black	Black	Black	Black	Black	Black	Black

Elementy wykresu cięcia

Poniższa ilustracja przedstawia elementy znajdujące się na każdym wykresie cięcia.

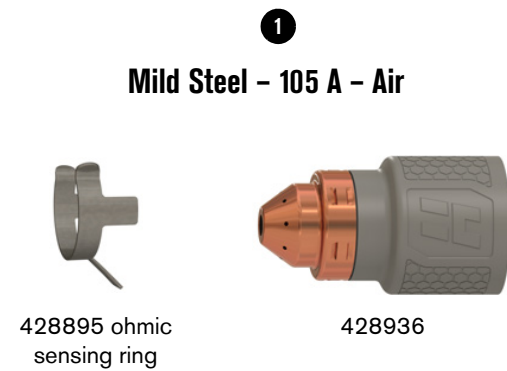

2 Metric

Material Thickness	Cut Height	Initial Pierce Height		Pierce Delay	Best Quality		Highest Production		Kerf Width
		mm	%		mm/min	volts	mm/min	volts	
6	3.2	6.4	200	0.5	3960	143	4880	143	2.2
20				1.0	790	153	940	152	2.8
40				Edge start		200	172	250	170

2 English

Material Thickness	Cut Height	Initial Pierce Height		Pierce Delay	Best Quality		Highest Production		Kerf Width
		inches	%		in/min	volts	in/min	volts	
1/4	0.125	0.25	200	0.5	156	143	192	143	0.086
3/4				1.0	33	152	40	151	0.108
1-1/2				Edge start		9	170	10	168

4 Gas flow rate – slpm / scfh

236 / 500	Hot (cutflow)
311 / 660	Cold (postflow)

1 Typ metalu:

- Stal miękka
- Stal nierdzewna
- Aluminium

Proces cięcia:

- **A** = Natężenie prądu. Ustawienie natężenia prądu dotyczy wszystkich ustawień podanych na tej stronie.
- W zastosowaniach **FineCut** w tabelach danych cięcia jest dostępne ustawienie natężenia prądu odpowiadające poszczególnym grubościom. Ten przewodnik zawiera tabele dotyczące dużych i małych szybkości. Ustawienia dużej szybkości mogą zapewnić lepszą jakość cięcia i mniejszą ilość zużycia przy niektórych grubościach, jeśli tylko stół cięcia umożliwia cięcie przy takich ustawieniach.

Typy gazu:

- **Powietrze** (lub azot)

Aby połączyć wkład do obróbki zmechanizowanej z kontrolerem wysokości palnika (THC), należy użyć **pierścienia do wykrywania omowego**. Należy go zamontować na wkładzie, jak przedstawiono na rysunku. Zestaw 428895 zawiera 3 pierścienie do wykrywania omowego (420580).

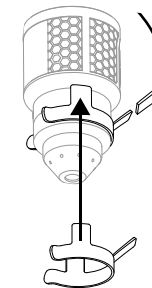

2 Metric = Metryczne jednostki miar

English = Anglosaskie jednostki miar

Material Thickness = Grubość elementu obrabianego (ciętej metalowej płyty).

Cut Height = Odległość od końcówki wkładu do elementu obrabianego podczas cięcia.

Initial Pierce Height = Odległość od końcówki wkładu do elementu obrabianego podczas aktywacji palnika, przed jego obniżeniem na wysokość cięcia.

Pierce Delay = Czas, przez jaki łuk plazmowy pozostaje w bezruchu na wysokości przebijania przed rozpoczęciem cięcia elementu obrabianego.

Best Quality (Cut Speed i Arc Voltage*) = Ustawienia zapewniające punkt początkowy do wyznaczenia najlepszej jakości cięcia (najlepszy kąt, najmniejsza ilość zużycia, najlepsze wykończenie ciętej powierzchni). Aby uzyskać oczekiwaną jakość cięcia, szybkość należy dostosować do warunków cięcia i systemu cięcia.

Highest Production (Cut Speed i Arc Voltage*) = Ustawienia, które zwiększają szybkości cięcia o 20–30%. Wybranie takich szybkości zapewnia większą liczbę ciętych części, ale niekoniecznie najlepszą możliwą jakość cięcia.

Kerf Width = Szerokość materiału usuniętego podczas cięcia. Szerokości szczelin służą jedynie jako odniesienie. Firma Hypertherm uzyskała je za pomocą ustawień „Najlepsza jakość”. Różnice między poszczególnymi instalacjami i składem materiału mogą powodować, że rzeczywiste wyniki będą się różnić od przedstawionych w tabelach.

* Informacje na temat używania napięcia łuku do kontrolowania wysokości cięcia można znaleźć w dokumencie *Powermax65/85/105 SYNC Mechanized Cutting Guide (Podręcznik cięcia zmechanizowanego do systemu Powermax65/85/105 SYNC)* (810480).

3 Jednostki miary:

- **mm** = milimetry
- **%** = procenty
- **seconds** = sekundy
- **mm/min** = milimetry na minutę
- **volts** = wolty
- **inches** = cale
- **in/min** = cale na minutę
- **A** = Ampery (wykresy FineCut)

Edge start = Rozpoczynanie cięcia od krawędzi elementu obrabianego.

4 Na każdym wykresie cięcia znajdują się szybkości przepływu dotyczące gorącego i zimnego gazu.

- **slpm** = standardowy litr na minutę
- **scfh** = standardowe stopy sześciennie na godzinę

Hot (cutflow) = Łuk plazmowy jest włączony, a podczas cięcia występuje ciągły przepływ gazu.

Cold (postflow) = Łuk plazmowy jest wyłączony i przez kilka sekund po zakończeniu cięcia utrzymuje się stały przepływ gazu. Szybkość przepływu dotyczy również trybu testowania gazu.

Como usar as tabelas de corte (Português/Portuguese)

⚠️ ADVERTÊNCIA



RISCOS DE EXPLOSÃO – CORTE COM ALUMÍNIO PRÓXIMO À ÁGUA

Cortes subaquáticos com gases combustíveis ou alumínio podem causar risco de explosão.

- NÃO corte sob a água com gases combustíveis que contenham hidrogênio.
- NÃO corte ligas de alumínio sob a água ou em mesas de água, a não ser que consiga evitar o acúmulo de hidrogênio.

Fazer isso pode causar uma explosão durante a operação do sistema de corte. Consulte o *Safety and Compliance Manual (Manual de Segurança e de Conformidade)* (80669C) para obter mais informações.

⚠️ ADVERTÊNCIA



RISCO DE EXPLOSÃO – CORTE COM GASES INFLAMÁVEIS OU GASES OXIDANTES

Não use gases inflamáveis ou gases oxidantes com os sistemas Powermax. Esses gases podem causar condições explosivas durante as operações de corte a plasma.

Um exemplo de gás oxidante é o oxigênio. Exemplos de gases inflamáveis: acetileno, propileno, metano e hidrogênio puro. Consulte o *Safety and Compliance Manual (Manual de Segurança e de Conformidade)* (80669C) para obter mais informações.

Para obter mais informações

- Para obter mais informações sobre como integrar seu sistema Powermax® com uma configuração de corte mecanizado, consulte o *Powermax65/85/105 SYNC Mechanized Cutting Guide (Guia de corte mecanizado da Powermax65/85/105 SYNC)* (810480).
- Para obter mais informações sobre o sistema, consulte o *Powermax65/85/105 SYNC Operator Manual (Manual do Operador da Powermax65/85/105 SYNC)* (810470).



Faça o download desses documentos em www.hypertherm.com/docs.

Sobre as tabelas de corte

As tabelas de corte nesse guia são um bom ponto de partida. Ajuste as variáveis nas tabelas de corte conforme necessário para obter os resultados ideais para o seu equipamento de corte e ambiente.

As tabelas de corte estão incluídas para:

- Corte de aço-carbono, aço inoxidável e alumínio a 45 A – 105 A com ar usando refis de corte padrão
- Corte de aço-carbono e aço inoxidável com ar usando refis FineCut



A Hypertherm coletou os dados da tabela de corte usando refis novos e obedecendo a todos os requisitos de alimentação elétrica, suprimento de gás e condições do local.

Selecione o cartucho que melhor se adequa ao material que deseja cortar

	Espessura do material no sistema métrico (mm)											
	0,5	1	2	3	5	8	10	12	15	20	25	30
FineCut	Black	Black	Black	Black	Black	Black	Black	Black	Black	Black	Black	Black
45 A	Light	Light	Light	Light	Light	Light	Light	Light	Light	Light	Light	Light
65 A	Light	Light	Light	Light	Light	Light	Light	Light	Light	Light	Light	Light
85 A	Light	Light	Light	Light	Light	Light	Light	Light	Light	Light	Light	Light
105 A	Light	Light	Light	Light	Light	Light	Light	Light	Light	Light	Light	Light

Qualidade de corte ideal
Qualidade de corte quase ideal
Menor qualidade de corte ou velocidade

	Espessura do material no sistema imperial (pol)										
	0.02	0.06	1/8	1/4	3/8	1/2	5/8	3/4	1	1-1/4	1-1/2
FineCut	Black	Black	Black	Black	Black	Black	Black	Black	Black	Black	Black
45 A	Light	Light	Light	Light	Light	Light	Light	Light	Light	Light	Light
65 A	Light	Light	Light	Light	Light	Light	Light	Light	Light	Light	Light
85 A	Light	Light	Light	Light	Light	Light	Light	Light	Light	Light	Light
105 A	Light	Light	Light	Light	Light	Light	Light	Light	Light	Light	Light

Elementos da tabela de corte

A ilustração a seguir identifica os elementos presentes em cada tabela de corte.

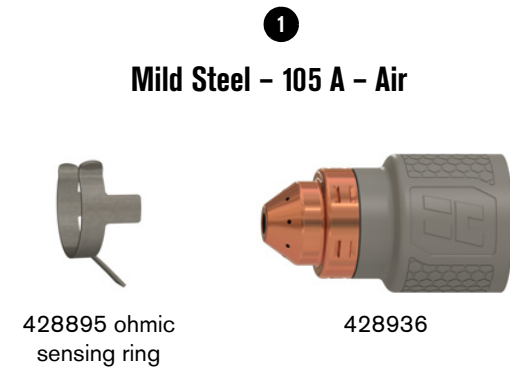

2 Metric

Material Thickness	Cut Height	Initial Pierce Height		Pierce Delay	Best Quality		Highest Production		Kerf Width
		mm	%		mm/min	volts	mm/min	volts	
6	3.2	6.4	200	0.5	3960	143	4880	143	2.2
20				1.0	790	153	940	152	2.8
40				Edge start		200	172	250	170

2 English

Material Thickness	Cut Height	Initial Pierce Height		Pierce Delay	Best Quality		Highest Production		Kerf Width
		inches	%		in/min	volts	in/min	volts	
1/4	0.125	0.25	200	0.5	156	143	192	143	0.086
3/4				1.0	33	152	40	151	0.108
1-1/2				Edge start		9	170	10	168

Gas flow rate – slpm / scfh

236 / 500	Hot (cutflow)
311 / 660	Cold (postflow)

- 1** Tipo de metal:
- Aço-carbono
 - Aço inoxidável
 - Alumínio

Processo de corte:

- **A** = corrente. A corrente se aplica a todos os ajustes apresentados na página em questão.
- Nas tabelas **FineCut**, a corrente para cada espessura está incluída na tabela de corte. Esse guia inclui tabelas para alta velocidade e baixa velocidade. Configurações de alta velocidade podem proporcionar melhor qualidade de corte e menos escória em algumas espessuras, se a mesa de corte permitir o corte nessa configuração.

Tipos de gás:

- **Ar** (ou nitrogênio)

Use um **anel de sensoriamento ôhmico** para conectar um cartucho mecanizado a um sistema de controle de altura da tocha (THC). Instale-o no cartucho, conforme mostrado. O kit 428895 inclui 3 anéis de sensoriamento ôhmico (420580).

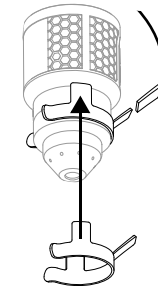

- 2** **Metric** = Medida métrica

English = Medida imperial

Material Thickness = Espessura da peça de trabalho (metal que está sendo cortado).

Cut Height = Distância entre a ponta do refil e a peça de trabalho durante o corte.

Initial Pierce Height = Distância entre a ponta do refil e a peça de trabalho quando a tocha é disparada, antes da descida até a altura de corte.

Pierce Delay = Tempo em que o arco plasma permanece parado na altura de perfuração enquanto corta a peça de trabalho.

Best Quality (Cut Speed e Arc Voltage*) = Configurações que fornecem o ponto de partida para alcançar a melhor qualidade de corte (melhor ângulo, mínimo de escória, melhor acabamento da superfície de corte). Ajuste a velocidade de sua aplicação e do sistema de corte para obter o resultado desejado.

Highest Production (Cut Speed e Arc Voltage*) = Configurações que aumentam as velocidades de corte em 20% – 30%. Essas velocidades geram um maior número de peças cortadas, mas não necessariamente com a melhor qualidade de corte possível.

Kerf Width = Largura do material removido pelo processo de corte. As larguras de kerf servem somente para referência. A Hypertherm as obtém por meio das configurações de “Best Quality (melhor qualidade)”. As diferenças entre instalações e composição do material podem causar resultados reais diferentes dos resultados apresentados nas tabelas.

* Para informações sobre como usar a tensão do arco para controlar a altura de corte, consulte o *Powermax65/85/105 SYNC Mechanized Cutting Guide (Guia de Corte Mecanizado da Powermax65/85/105 SYNC)* (810480).

- 3** Unidades de medida:

- **mm** = milímetros
- **%** = porcentagem
- **seconds** = segundos
- **mm/min** = milímetros por minuto
- **volts** = volts
- **inches** = polegadas
- **in/min** = polegadas por minuto
- **A** = corrente (tabelas FineCut)

Edge start = Iniciar o corte pela borda da peça de trabalho.

- 4** Cada tabela de corte relaciona as taxas de fluxo de gás quente e frio.

- **slpm** = litros por minuto padrão
- **scfh** = pés cúbicos por hora padrão

Hot (cutflow) = O arco plasma está ativo e há uma vazão constante de gás durante o corte.

Cold (postflow) = O arco plasma está desativado e há uma vazão constante de gás por vários segundos após o término do corte. Essa faixa de fluxo também se aplica ao modo de teste de gás.

Использование технологических карт резки (Русский/Russian)

⚠ БЕРЕГИСЬ!



ОПАСНОСТЬ ВЗРЫВА: РЕЗКА АЛЮМИНИЯ ВОЗЛЕ ВОДЫ

Подводная резка с применением горючих газов или резка алюминия может привести к возникновению опасности взрыва.

- ЗАПРЕЩАЕТСЯ выполнять подводную резку с применением горючих газов, содержащих водород.
- При невозможности не допустить скопления водорода ЗАПРЕЩАЕТСЯ проводить резку алюминиевых сплавов под водой или на водяном столе.

Это может привести к взрыву при работе системы резки. Дополнительные сведения см. в документе *Safety and Compliance Manual (Руководство по безопасности и соответствию)* (80669C).

⚠ БЕРЕГИСЬ!



ОПАСНОСТЬ ВЗРЫВА: РЕЗКА С ПРИМЕНЕНИЕМ ГОРЮЧИХ ИЛИ ОКИСЛЯЮЩИХ ГАЗОВ

С системами Powermax запрещается использовать горючие или окисляющие газы. Использование этих газов может привести к взрывоопасному состоянию при выполнении операций плазменной резки.

В качестве примера окисляющего газа можно привести кислород. К горючим газам относятся, в частности, ацетилен, пропилен, метан и чистый водород. Дополнительные сведения см. в документе *Safety and Compliance Manual (Руководство по безопасности и соответствию)* (80669C).

Дополнительные сведения

- Дополнительные сведения об использовании системы Powermax® в составе установки механизированной резки см. в документе *Powermax65/85/105 SYNC Mechanized Cutting Guide (Powermax65/85/105 SYNC Руководство по механизированной резке)* (810480).
- Дополнительные сведения о Вашей системе см. в документе *Powermax65/85/105 SYNC Operator Manual (Powermax65/85/105 SYNC Руководство оператора)* (810470).



Указанные документы можно загрузить с веб-сайта Hypertherm по адресу: www.hypertherm.com/docs.

О технологических картах резки

Технологические карты резки, приведенные в настоящем руководстве, могут быть использованы в качестве хорошей отправной точки для настройки параметров работы с системами. Для получения оптимальных результатов с учетом используемого оборудования и среды резки есть возможность корректировать приведенные в картах значения.

Предоставлены технологические карты резки для следующих процессов:

- Резка низкоуглеродистой стали, нержавеющей стали и алюминия воздухом при силе тока 45–105 А с использованием стандартных наборов расходных деталей для резки
- Резка низкоуглеродистой стали и нержавеющей стали воздухом с использованием наборов расходных деталей FineCut



Данные, указанные в технологических картах резки, получены компанией Hypertherm при использовании новых наборов расходных деталей и соблюдении всех требований к подаче электропитания, подаче газа и условиям на месте проведения работ.

Выбор наиболее подходящего неразъемно-комплектного набора расходных деталей для нужного материала

	Толщина материала (мм)											
	0,5	1	2	3	5	8	10	12	15	20	25	30
FineCut	■	■	■	■	■							
45 A	■	■	■	■	■							
65 A		■	■	■	■	■	■	■	■	■	■	■
85 A			■	■	■	■	■	■	■	■	■	■
105 A				■	■	■	■	■	■	■	■	■

Оптимальное качество резки

Качество резки, близкое к оптимальному

Качество или скорость резки ниже оптимального уровня

	Толщина материала (дюймы)										
	0.02	0.06	1/8	1/4	3/8	1/2	5/8	3/4	1	1-1/4	1-1/2
FineCut	■	■	■								
45 A	■	■	■	■							
65 A		■	■	■	■	■	■	■	■	■	■
85 A			■	■	■	■	■	■	■	■	■
105 A				■	■	■	■	■	■	■	■

Элементы технологической карты резки

На рисунке ниже показаны элементы, которые есть в каждой технологической карте резки.

1
Mild Steel – 105 A – Air



428895 ohmic sensing ring

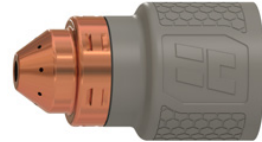

428936

2 Metric

Material Thickness	Cut Height	Initial Pierce Height	Pierce Delay	Best Quality		Highest Production		Kerf Width	
				Cut Speed	Arc Voltage	Cut Speed	Arc Voltage		
mm	mm	mm	%	seconds	mm/min	volts	mm/min	volts	mm
6	3.2	6.4	200	0.5	3960	143	4880	143	2.2
20				1.0	790	153	940	152	2.8
40				Edge start	200	172	250	170	5.1

2 English

Material Thickness	Cut Height	Initial Pierce Height	Pierce Delay	Best Quality		Highest Production		Kerf Width	
				Cut Speed	Arc Voltage	Cut Speed	Arc Voltage		
inches	inches	inches	%	seconds	in/min	volts	in/min	volts	inches
1/4	0.125	0.25	200	0.5	156	143	192	143	0.086
3/4				1.0	33	152	40	151	0.108
1-1/2				Edge start	9	170	10	168	0.183

4 Gas flow rate – slpm / scfh

236 / 500	Hot (cutflow)
311 / 660	Cold (postflow)

1 Вид металла:

- низкоуглеродистая сталь
- нержавеющая сталь
- алюминий

Процесс резки:

- A** = сила тока. Значение силы тока действительно для всех настроек на данной странице.
- В технологических картах резки для деталей **FineCut** указаны значения силы тока для всех возможных значений толщины обрабатываемого материала. Это руководство включает в себя технологические карты резки как для высоких, так и для низких скоростей. Высокая скорость резки может обеспечить более высокое качество резки и меньшее образование окалины для материалов определенной толщины (если стол для резки позволяет использовать настройки высокой скорости).

Вид газа:

- воздух (или азот)

Кольцо омического контакта используется для подсоединения набора расходных деталей для механизированной резки к системе регулировки высоты резака. Установите кольцо на набор, как показано на рисунке. В комплект 428895 входит 3 кольца омического контакта (420580).

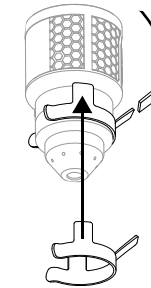

2 Metric = Значения в метрической системе

English = Значения в британской системе

Material Thickness = Толщина заготовки (разрезаемого листа металла).

Cut Height = Расстояние между наконечником набора расходных деталей и заготовкой в процессе резки.

Initial Pierce Height = Расстояние между наконечником набора расходных деталей и заготовкой в момент зажигания резака до опускания резака на высоту резки.

Pierce Delay = Время, в течение которого при разрезании заготовки плазменная дуга остается на высоте прожига.

Best Quality (Cut Speed и Arc Voltage*) = Настройки, которые можно использовать в качестве отправной точки для определения опытным путем в процессе дальнейшей работы наилучшего качества резки (наилучший угол, минимальное образование окалины, наилучшее качество поверхности резки). Для получения требуемого результата необходимо откорректировать значение скорости с учетом процесса и применяемой системы.

Highest Production (Cut Speed и Arc Voltage*) = Настройки, которые позволяют повысить скорость резки на 20–30 %. Повышение скорости резки позволяет увеличить количество вырезаемых деталей, но не всегда позволяет получить самое лучшее качество резки.

Kerf Width = Ширина материала, удаляемого в процессе резки. Значения ширины разреза в технологических картах резки указаны исключительно в справочных целях. Они были получены в Hypertherm при использовании настроек «Наилучшее качество». В зависимости от конфигурации системы и состава материалов фактические результаты могут отличаться от указанных в таблицах.

* Сведения о том, каким образом можно управлять высотой резки посредством дугового напряжения, см. в документе *Powermax65/85/105 SYNC Mechanized Cutting Guide (Powermax65/85/105 SYNC Руководство по механизированной резке с использованием систем)* (810480).

3 Единицы измерения:

- mm = миллиметры
- % = процентное значение
- seconds = секунды
- mm/min = миллиметры в минуту
- volts = вольты
- inches = дюймы
- in/min = дюймы в минуту
- A = сила тока (технологические карты резки FineCut)

Edge start = запуск резки на краю заготовки.

4 На каждой технологической карте резки приведены данные по скорости потоков горячего и холодного газа.

- slpm = Стандартные литры в минуту
- scfh = Стандартные кубические футы в час

Hot (cutflow) = Плазменная дуга включена, при резке подается стабильный поток газа.

Cold (postflow) = Плазменная дуга выключена, по окончании резки стабильный поток газа подается в течение нескольких секунд. Указанное значение скорости потока также применяется в режиме проверки газа.

Cómo utilizar las tablas de corte (Español/Spanish)

⚠ ADVERTENCIA



PELIGRO DE EXPLOSIÓN – CORTE CON ALUMINIO CERCA DEL AGUA

El corte bajo agua con gases combustibles o aluminio puede provocar un peligro de explosión.

- NO corte bajo agua con gases combustibles que tengan hidrógeno.
- NO corte aleaciones de aluminio bajo agua o sobre una mesa de agua, a menos que pueda evitar la acumulación de gas de hidrógeno.

De hacerlo, puede generarse una explosión durante la operación del sistema de corte. Para más información, ver el *Safety and Compliance Manual (Manual de Seguridad y Cumplimiento)* (80669C).

⚠ ADVERTENCIA



PELIGRO DE EXPLOSIÓN – CORTE CON GASES INFLAMABLES U OXIDANTES

No use gases inflamables u oxidantes con los sistemas Powermax. Estos gases pueden generar una explosión durante operaciones de corte por plasma.

El oxígeno es un ejemplo de un gas oxidante. Algunos ejemplos de gases inflamables son: acetileno, propileno, metano e hidrógeno puro. Para más información, refiérase al *Safety and Compliance Manual (Manual de Seguridad y Cumplimiento)* (80669C).

Para más información

- Para obtener más información sobre cómo integrar su sistema Powermax® con un ajuste de corte mecanizado, refiérase a la *Powermax65/85/105 SYNC Mechanized Cutting Guide (Guía de corte mecanizado de Powermax65/85/105 SYNC)* (810480).
- Para más información sobre su sistema, refiérase al *Powermax65/85/105 SYNC Operator Manual (Manual del operador de Powermax65/85/105 SYNC)* (810470).

📄 Descargue estos documentos en www.hypertherm.com/docs.

Acerca de las tablas de corte

Las tablas de corte de esta sección son un buen punto de partida. Ajuste las variables de las tablas de corte según se requiera para obtener resultados óptimos para su equipo de corte y ambiente.

Se incluyen tablas de corte para lo siguiente:

- Cortar acero al carbono, acero inoxidable y aluminio a 45 A-105 A con aire usando cartuchos estándar de corte
- Cortar acero al carbono y acero inoxidable con aire usando cartuchos FineCut



Hypertherm recopiló los datos de la tabla de corte utilizando cartuchos nuevos y cumpliendo con todos los requisitos de suministro eléctrico, alimentación de gas y condiciones del lugar de trabajo.

Seleccione el mejor cartucho para el material que desea cortar

Cartucho	Espesor del material en medidas métricas (mm)											
	0,5	1	2	3	5	8	10	12	15	20	25	30
FineCut	■	■	■	■	■							
45 A	■	■	■	■	■							
65 A			■	■	■	■	■	■	■	■	■	■
85 A				■	■	■	■	■	■	■	■	■
105 A						■	■	■	■	■	■	■

Calidad de corte óptima
Calidad de corte casi óptima
Disminución de la calidad de corte o la velocidad

Cartucho	Espesor del material en medidas anglosajonas (pulg.)										
	0.02	0.06	1/8	1/4	3/8	1/2	5/8	3/4	1	1-1/4	1-1/2
FineCut	■	■	■								
45 A	■	■	■	■							
65 A			■	■	■	■	■	■	■	■	■
85 A				■	■	■	■	■	■	■	■
105 A					■	■	■	■	■	■	■

Elementos de la tabla de corte

La siguiente ilustración identifica los elementos que conforman la tabla de corte.

1

Mild Steel – 105 A – Air



428895 ohmic sensing ring



428936

2 Metric

Material Thickness	Cut Height	Initial Pierce Height	Pierce Delay	Best Quality		Highest Production		Kerf Width	
				Cut Speed	Arc Voltage	Cut Speed	Arc Voltage		
mm	mm	mm	%	seconds	mm/min	volts	mm/min	volts	mm
6	3.2	6.4	200	0.5	3960	143	4880	143	2.2
20				1.0	790	153	940	152	2.8
40				Edge start		200	172	250	170

2 English

Material Thickness	Cut Height	Initial Pierce Height	Pierce Delay	Best Quality		Highest Production		Kerf Width	
				Cut Speed	Arc Voltage	Cut Speed	Arc Voltage		
inches	inches	inches	%	seconds	in/min	volts	in/min	volts	inches
1/4	0.125	0.25	200	0.5	156	143	192	143	0.086
3/4				1.0	33	152	40	151	0.108
1-1/2				Edge start		9	170	10	168

4 Gas flow rate – slpm / scfh

236 / 500	Hot (cutflow)
311 / 660	Cold (postflow)

1

Tipo de metal:

- Acero al carbono
- Acero inoxidable
- Aluminio

Proceso de corte:

- **A** = amperaje. El amperaje aplica a todos los ajustes de esa página.
- En las tablas **FineCut**, el valor de amperaje de cada espesor aparece en la tabla de corte. Esta guía incluye tablas de alta y baja velocidad. Los ajustes de alta velocidad pueden lograr mejor calidad de corte y menos escoria en algunos espesores, si es que la mesa de corte permite cortar con esos ajustes.

Tipo de gas:

- Aire (o nitrógeno)

Use un **anillo de sensado óhmico** para conectar un cartucho mecanizado a un sistema de control de altura de la antorcha (THC). Se debe instalar en el cartucho, tal y como se muestra. El juego 428895 incluye 3 anillos de sensado óhmico (420580).

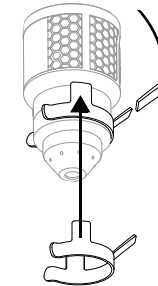

2

Metric = medidas métricas

English = unidades anglosajonas

Material Thickness = espesor de la pieza a cortar (placa de metal a cortar).

Cut Height = distancia entre la punta del cartucho y la pieza a cortar durante el corte.

Initial Pierce Height = distancia entre la punta del cartucho y la pieza a cortar en el momento en que se enciende la antorcha, antes de descender a la altura de corte.

Pierce Delay = intervalo de tiempo que el arco de plasma se queda inmóvil a la altura de perforación mientras corta la pieza a cortar.

Best Quality (Cut Speed y Arc Voltage*) = ajustes que dan el punto de partida para lograr la mejor calidad de corte (mejor ángulo, menos escoria, mejor acabado de la superficie de corte). Ajuste la velocidad según su aplicación y sistema de corte a fin de obtener el resultado buscado.

Highest Production (Cut Speed y Arc Voltage*) = ajustes que aumentan las velocidades de corte en un 20%-30%. Estas velocidades otorgan una mayor cantidad de piezas a cortar, pero no necesariamente la mejor calidad de corte posible.

Kerf Width = ancho de material que se quita por el proceso de corte. Los anchos de sangría se dan solo como referencia. Hypertherm los obtuvo utilizando los ajustes de "Best Quality (mejor calidad)". Es posible que los resultados específicos de distintas instalaciones y composición de materiales difieran de los que se muestran en las tablas.

* Para obtener más información sobre cómo usar el voltaje del arco para controlar la altura de corte, refiérase a *Powermax65/85/105 SYNC Mechanized Cutting Guide (Guía de corte mecanizado)* (810480).

3

Unidades de medida:

- **mm** = milímetros
- **%** = porcentaje
- **seconds** = segundos
- **mm/min** = milímetros por minuto
- **volts** = voltios
- **inches** = pulgadas
- **in/min** = pulgadas por minuto
- **A** = amperaje (tablas FineCut)

Edge start = empieza el corte desde el borde de la pieza a cortar.

4

Cada tabla de corte relaciona los rangos de flujo de gas frío y caliente.

- **slpm** = litros estándar por minuto
- **scfh** = pies cúbicos estándar por hora

Hot (cutflow) = el arco de plasma está encendido y hay un flujo continuo de gas durante el corte.

Cold (postflow) = el arco de plasma está apagado y hay un flujo continuo de gas durante varios segundos después de que se completa el corte. Este rango de flujo también se aplica al modo de prueba de gas.

การใช้แผนภูมิการตัด (ภาษาไทย/Thai)

คำเตือน



อันตรายจากการระเบิด - การตัดด้วยอลูมิเนียมเกล็น้ำ
การตัดใต้น้ำโดยใช้แก๊สหรืออลูมิเนียมสามารถก่อให้เกิดอันตรายจากการระเบิดได้

- อย่าตัดใต้น้ำโดยใช้แก๊สที่มีไฮโดรเจนเป็นเชื้อเพลิง
- อย่าตัดอลูมิเนียมผสมใต้น้ำหรือใต้น้ำหล่อ ยกเว้นในกรณีที่สามารถป้องกันการสะสมของแก๊สไฮโดรเจน

การตัดดังกล่าวสามารถก่อให้เกิดการระเบิดระหว่างการดำเนินงานของระบบการตัด สำหรับข้อมูลเพิ่มเติม โปรดอ่าน *Safety and Compliance Manual (คู่มือด้านความปลอดภัยและการปฏิบัติตามกฎ)* (80669C)

คำเตือน



อันตรายจากการระเบิด - การตัดด้วยแก๊สไวไฟหรือแก๊สออกซิไดซ์
อย่าใช้แก๊สไวไฟหรือแก๊สออกซิไดซ์กับระบบ Powermax แก๊สเหล่านี้สามารถก่อให้เกิด สภาพที่อาจทำให้เกิดการระเบิดระหว่างการตัดพลาสมา

ตัวอย่างของแก๊สออกซิไดซ์ได้แก่ ออกซิเจน ตัวอย่างของแก๊สที่เผาไหม้ได้คือ อะเซทิลีน โพรพิลีน มีเทน และไฮโดรเจนบริสุทธิ์ สำหรับข้อมูลเพิ่มเติม โปรดอ่าน *Safety and Compliance Manual (คู่มือด้านความปลอดภัยและการปฏิบัติตามกฎ)* (80669C)

ข้อมูลเพิ่มเติม

- สำหรับข้อมูลเพิ่มเติมเกี่ยวกับการผสมระบบ Powermax® เข้ากับการตั้งค่าการตัดแบบควบคุมด้วยเครื่องจักร โปรดดูข้อมูลใน *Powermax65/85/105 SYNC Mechanized Cutting Guide (คู่มือการตัดโดยใช้เครื่องจักร Powermax65/85/105 SYNC)* (810480)
- สำหรับข้อมูลเพิ่มเติมเกี่ยวกับระบบที่คุณใช้งานอยู่ โปรดอ่าน *Powermax65/85/105 SYNC Operator Manual (Powermax65/85/105 SYNC คู่มือสำหรับผู้ปฏิบัติงาน)* (810470)

ดาวน์โหลดเอกสารเหล่านี้ได้ที่ www.hypertherm.com/docs

เกี่ยวกับแผนภูมิการตัด

แผนภูมิการตัดในคู่มือนี้เป็นจุดเริ่มต้นที่ดีสำหรับการใช้งาน ปรับค่าตัวแปรในแผนภูมิการตัดตามต้องการเพื่อให้ได้ผลลัพธ์ที่เหมาะสมที่สุดสำหรับอุปกรณ์ที่ใช้งานและสิ่งแวดล้อม

ข้อมูลต่อไปนี้มีรวมอยู่ในแผนภูมิการตัด

- การตัดเหล็กเหนียว เหล็กสแตนเลส และอลูมิเนียมที่ 45 A – 105 A ด้วยลมโดยใช้คาร์ทริดจ์การตัดแบบมาตรฐาน
- การตัดเหล็กเหนียวและเหล็กสแตนเลสด้วยลมโดยใช้คาร์ทริดจ์ FineCut

Hypertherm เก็บรวบรวมข้อมูลแผนภูมิการตัดโดยใช้คาร์ทริดจ์ใหม่และปฏิบัติตามข้อกำหนดของการจ่ายไฟ การใช้แก๊ส และสภาพของสถานที่ปฏิบัติงาน

การเลือกคาร์ทริดจ์ที่เหมาะสมที่สุดสำหรับตัดวัสดุที่ต้องการ

คาร์ทริดจ์	ความหนาของวัสดุตามระบบเมตริก (มม.)												
	0.5	1	2	3	5	8	10	12	15	20	25	30	
FineCut (ไฟน์คัท)	■	■	■	■	■								
45 A	■	■	■	■	■	■	■	■	■	■	■	■	■
65 A			■	■	■	■	■	■	■	■	■	■	■
85 A				■	■	■	■	■	■	■	■	■	■
105 A					■	■	■	■	■	■	■	■	■

คุณภาพการตัดที่มีประสิทธิภาพสูงสุด

คุณภาพการตัด ที่ใกล้เคียงกับการมีประสิทธิภาพสูงสุด

คุณภาพ หรือความเร็วในการตัดลดลง

คาร์ทริดจ์	ความหนาของวัสดุตามระบบอังกฤษ (นิ้ว)											
	0.02	0.06	1/8	1/4	3/8	1/2	5/8	3/4	1	1-1/4	1-1/2	
FineCut (ไฟน์คัท)	■	■	■									
45 A	■	■	■	■	■	■	■	■	■	■	■	■
65 A		■	■	■	■	■	■	■	■	■	■	■
85 A			■	■	■	■	■	■	■	■	■	■
105 A				■	■	■	■	■	■	■	■	■

องค์ประกอบของแผนภูมิการตัด

ภาพประกอบต่อไปนี้แสดงองค์ประกอบที่อยู่ในแผนภูมิการตัดแต่ละประเภท

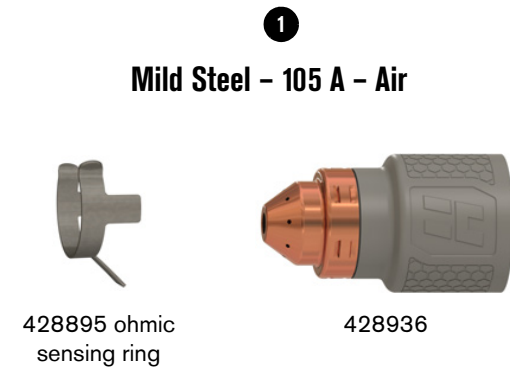

2 Metric

Material Thickness	Cut Height	Initial Pierce Height	Pierce Delay	Best Quality		Highest Production		Kerf Width	
				Cut Speed	Arc Voltage	Cut Speed	Arc Voltage		
mm	mm	mm	%	seconds	mm/min	volts	mm/min	volts	mm
6	3.2	6.4	200	0.5	3960	143	4880	143	2.2
20				1.0	790	153	940	152	2.8
40				Edge start		200	172	250	170

2 English

Material Thickness	Cut Height	Initial Pierce Height	Pierce Delay	Best Quality		Highest Production		Kerf Width	
				Cut Speed	Arc Voltage	Cut Speed	Arc Voltage		
inches	inches	inches	%	seconds	in/min	volts	in/min	volts	inches
1/4	0.125	0.25	200	0.5	156	143	192	143	0.086
3/4				1.0	33	152	40	151	0.108
1-1/2				Edge start		9	170	10	168

4 Gas flow rate – slpm / scfh

236 / 500	Hot (cutflow)
311 / 660	Cold (postflow)

- 1** ประเภทของโลหะ
- เหล็กเหนียว
 - เหล็กสแตนเลส
 - อลูมิเนียม

กระบวนการตัด

- **A** = จำนวนแอมแปร์ จำนวนแอมแปร์ที่ระบุจะใช้กับการตั้งค่าทั้งหมดในหน้าเอกสารดังกล่าว
- ในแผนภูมิ **FineCut** จำนวนแอมแปร์สำหรับความหนาแต่ละแบบมีรวมอยู่ในแผนภูมิการตัด คู่มือนี้ประกอบด้วยแผนภูมิของความถี่สูงและความเร็วต่ำ หากโต๊ะตัดที่ใช้งานอยู่สามารถใช้กับการตั้งค่าเหล่านี้ได้ การตั้งค่าความเร็วสูงสามารถทำให้การตัดมีคุณภาพดีขึ้นและมีโอกาสของเสียจากการตัดในปริมาณที่น้อยลงสำหรับการตัดวัสดุที่มีความหนาบางระดับ

ประเภทของแก๊ส:

- **อากาศ** (หรือไนโตรเจน)
- ใช้วงแหวนตรวจจับแบบโอห์มิกเพื่อเชื่อมต่อคาร์ทริดจ์สำหรับเครื่องจักรเข้ากับระบบควบคุมความสูงของหัวตัด (THC) ติดตั้งวงแหวนตรวจจับแบบโอห์มิกบนคาร์ทริดจ์ ตามที่แสดงไว้ชุด 428895 ประกอบด้วย วงแหวนตรวจจับแบบโอห์มิก 3 ชิ้น (420580)

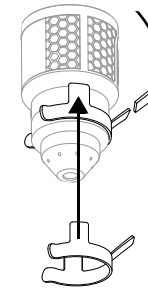

- 2** **Metric** = การวัดระบบเมตริก
- English** = การวัดระบบอังกฤษ

Material Thickness = ความหนาของวัสดุที่จะตัด (แผ่นโลหะที่จะตัด)

Cut Height = ระยะห่างระหว่างปลายคาร์ทริดจ์กับวัสดุที่จะตัดขณะทำการตัด

Initial Pierce Height = ระยะห่างระหว่างปลายคาร์ทริดจ์กับวัสดุที่จะตัดเมื่อหัวพ่นไฟออกมา ก่อนจะลดลงไปอยู่ที่ความสูงของการตัด

Pierce Delay = ระยะเวลาที่อาร์กของพลาสมาหยุดนิ่งอยู่ที่ความสูงของการเจาะขณะตัดผ่านชิ้นงาน

Best Quality (Cut Speed และ Arc Voltage*) = การตั้งค่าที่กำหนดจุดเริ่มต้นเพื่อค้นหาคุณภาพการตัดที่ดีที่สุด (มุมที่ดีที่สุด เกิดกากของเสียที่น้อยที่สุด ได้พื้นผิวการตัดที่ดีที่สุด) ปรับความเร็วในการใช้งานและระบบการตัดเพื่อให้ได้ผลงานที่ต้องการ

Highest Production (Cut Speed และ Arc Voltage*) = การตั้งค่าที่เพิ่มความเร็วในการตัด 20% – 30% ความเร็วเหล่านี้เพิ่มจำนวนชิ้นงานในการตัดแต่อาจไม่ได้ให้คุณภาพในการตัดที่ดีที่สุด

Kerf Width = ความกว้างของวัสดุที่กระบวนการตัดได้ตัดออก ความกว้างนี้ใช้สำหรับการอ้างอิงเท่านั้น Hypertherm ใช้การตั้งค่าเพื่อให้ได้ “Best Quality (คุณภาพที่ดีที่สุด)” ความแตกต่างระหว่างการติดตั้งและองค์ประกอบของวัสดุอาจทำให้ผลงานตัดที่ได้จริงแตกต่างไปจากข้อมูลที่แสดงอยู่ในตาราง

* สำหรับข้อมูลเกี่ยวกับวิธีใช้แรงดันไฟฟ้าของอาร์กเพื่อควบคุมความสูงของการตัด โปรดอ่าน Powermax65/85/105 SYNC Mechanized Cutting Guide (Power65/85/105 SYNC คู่มือการตัดโดยใช้เครื่องจักรคู่มือการตัด) (810480)

- 3** หน่วยการวัด
- mm = มิลลิเมตร
 - % = เปอร์เซ็นต์
 - seconds = วินาที
 - mm/min = มิลลิเมตรต่อนาที
 - volts = โวลต์
 - inches = นิ้ว
 - in/min = นิ้วต่อนาที
 - A = จำนวนแอมแปร์ (แผนภูมิ FineCut)

Edge start = การเริ่มต้นการตัดจากขอบของชิ้นงาน

- 4** แผนภูมิการตัดแต่ละแบบระบุอัตราการไหลของแก๊สแบบร้อนและเย็น

- slpm = ลิตรมาตรฐานต่อนาที
- scfh = ลูกบาศก์ฟุตมาตรฐานต่อชั่วโมง

Hot (cutflow) = อาร์กของพลาสมาเปิดใช้งานอยู่ และมีการไหลของแก๊สในระดับคงที่ขณะตัด

Cold (postflow) = อาร์กของพลาสมาปิดอยู่ และมีการไหลของแก๊สในระดับคงที่เป็นเวลาหลายวินาทีหลังตัดเสร็จ อัตราการไหลนี้จะใช้กับโหมดการทดสอบแก๊สด้วย

Kesim Tablolarının Kullanılması (Türkçe/Turkish)

UYARI



PATLAMA TEHLİKESİ - SU YAKININDA ALÜMİNYUM İLE KESİM

Yanıcı gazlar veya alüminyumla su altında kesme işlemi patlama tehlikesine neden olabilir.

- Hidrojen içeren yanıcı gazlarla su altında kesim YAPMAYIN.
- Hidrojen gazı birikimini önleyemediğiniz takdirde alüminyum alaşımlarını su altında veya bir sulu sehpa KESMEYİN.

Aksi takdirde, kesme sistemi çalıştırılırken patlama meydana gelebilir. Daha fazla bilgi için *Safety and Compliance Manual (Güvenlik ve Uyumluluk Kılavuzu)*'na (80669C) bakın.

UYARI



PATLAMA TEHLİKESİ - YANICI VEYA OKSİTLEYİCİ GAZLARLA KESME

Powermax sistemleriyle yanıcı veya oksitleyici gazları kullanmayın. Bu gazlar plazma kesme işlemleri sırasında patlama meydana gelmesine neden olabilir.

Oksitleyici gaza örnek olarak oksijen verilebilir. Yanıcı gazlara örnek olarak asetilen, propilen, metan ve saf hidrojen verilebilir. Daha fazla bilgi için, bkz. *Safety and Compliance Manual (Güvenlik ve Uyumluluk Kılavuzu)*'na (80669C) bakın.

Daha fazla bilgi için

- Powermax® sisteminizi bir mekanize kesim kurulumu ile entegre etmekle ilgili daha fazla bilgi almak için *Powermax65/85/105 SYNC Mechanized Cutting Guide (Powermax65/85/105 SYNC Mekanize Kesim Rehberi)*'ne (810480) bakın.
- Sisteminiz hakkında ek bilgi almak için *Powermax65/85/105 SYNC Operator Manual (Powermax65/85/105 SYNC Operatör Kullanma Kılavuzu)*'na (810470) bakın.



Bu belgeleri www.hypertherm.com/docs adresinden indirebilirsiniz.

Kesim tabloları hakkında

Bu rehberdeki kesim tabloları, iyi bir başlangıç noktasıdır. Kesim ekipmanınız ve ortamınızdan en iyi sonuçları almak için kesim tablolarındaki değişkenleri gerektiği gibi ayarlayın.

Kesim tabloları aşağıdakiler için verilir:

- 45 A-105 A'da standart kesme kartuşları ve hava ile siyah sac, paslanmaz çelik ve alüminyum kesimi
- FineCut kartuşlar ve hava ile siyah sac ve paslanmaz çelik kesimi



Hypertherm kesim tablosu verilerini yeni kartuşları kullanarak ve elektrik kaynağı, gaz kaynağı ve tesis koşulları açısından tüm gerekliliklere uyarak toplamıştır.

Kesmek istediğiniz malzemeye en uygun kartuşu seçin

Kartuş	Metrik malzeme kalınlığı (mm)											
	0,5	1	2	3	5	8	10	12	15	20	25	30
FineCut	■	■	■	■	■							
45 A	■	■	■	■	■							
65 A			■	■	■	■	■	■	■	■	■	■
85 A				■	■	■	■	■	■	■	■	■
105 A						■	■	■	■	■	■	■

Optimum kesim kalitesi
Optimum kesim kalitesine yakın
Düşük kesim kalitesi veya hız

Kartuş	İngiliz malzeme kalınlığı (inç)										
	0.02	0.06	1/8	1/4	3/8	1/2	5/8	3/4	1	1-1/4	1-1/2
FineCut	■	■	■	■	■						
45 A	■	■	■	■	■						
65 A			■	■	■	■	■	■	■	■	■
85 A				■	■	■	■	■	■	■	■
105 A						■	■	■	■	■	■

Kesim tablosu öğeleri

Aşağıdaki şemada her kesim tablosunda yer alan öğeler tanımlanmaktadır.

1

Mild Steel – 105 A – Air



428895 ohmic sensing ring

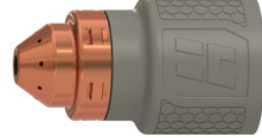

428936

2 Metric

Material Thickness	Cut Height	Initial Pierce Height	Pierce Delay	Best Quality		Highest Production		Kerf Width	
				Cut Speed	Arc Voltage	Cut Speed	Arc Voltage		
6	3.2	6.4	200	0.5	3960	143	4880	2.2	
20				1.0	790	153	940	152	2.8
40				Edge start		200	172	250	170

2 English

Material Thickness	Cut Height	Initial Pierce Height	Pierce Delay	Best Quality		Highest Production		Kerf Width	
				Cut Speed	Arc Voltage	Cut Speed	Arc Voltage		
1/4	0.125	0.25	200	0.5	156	143	192	0.086	
3/4				1.0	33	152	40	151	0.108
1-1/2				Edge start		9	170	10	168

4 Gas flow rate – slpm / scfh

236 / 500	Hot (cutflow)
311 / 660	Cold (postflow)

1

Metal tipi:

- Siyah Sac
- Paslanmaz Çelik
- Alüminyum

Kesme işlemi:

- A = Amperaj. Amperaj ayarı, bu sayfada verilen tüm ayarlar için geçerlidir.
- FineCut tablolarında, her bir kalınlık için amperaj ayarı kesim tablosuna dâhil edilmiştir. Bu rehber yüksek hız ve düşük hız tablolarını içerir. Kesim sehpa bu ayarlarda kesmenize izin veriyorsa yüksek hız ayarları bazı kalınlıklarda daha iyi kesim kalitesi ve daha az çapak üretebilir.

Gaz tipi:

- Hava (veya nitrojen)

Mekanize kartuşu torç yükseklik kontrolü (THC) sistemine bağlamak için bir **ohmik algılama halkası** kullanın. Kartuşu gösterildiği gibi takın. 428895 takımı 3 ohmik algılama halkası (420580) içerir.

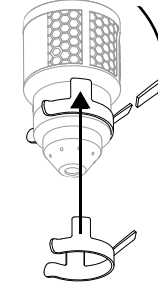

2

Metric = Metrik ölçümler

English = İngiliz ölçümler

Material Thickness = Çalışma parçasının (kesilen metal plaka) kalınlığı.

Cut Height = Kesme sırasında kartuş ile çalışma parçası arasındaki mesafe.

Initial Pierce Height = Torç kesme yüksekliğine inmeden önce, ateşlendiğinde kartuş ucu ile çalışma parçası arasındaki mesafe.

Pierce Delay = Plazma arkının çalışma parçasını keserken delme yüksekliğinde sabit kaldığı süre.

Best Quality (Cut Speed ve Arc Voltage*) = En iyi kesim kalitesini bulmak için başlangıç noktasını sağlayan ayarlar (en iyi açı, en az çapak, en iyi kesim yüzeyi bitirme). İstenilen sonucu elde etmek için hızı uygulamanıza ve kesme sisteminize göre ayarlayın.

Highest Production (Cut Speed ve Arc Voltage*) = Kesim hızlarını %20 - %30 oranında artıran ayarlar. Bu hızlarda daha fazla sayıda kesim parçası elde edilir ancak mümkün olan en iyi kesim kalitesi beklenmez.

Kerf Width = Kesme işlemiyle kaldırılan malzemenin genişliği. Kerf genişlikleri sadece referans içindir. Hypertherm bunları "En İyi Kalite" ayarlarını kullanarak elde etmiştir. Kurulumlar ve malzeme kompozisyonları arasındaki farklılıklar, gerçek sonuçların tablolarda gösterilenlerden farklı olmasına neden olabilir.

* Kesme yüksekliğinin kontrol edilmesi için ark geriliminin nasıl kullanılacağı hakkında bilgi almak için *Powermax65/85/105 SYNC Mechanized Cutting Guide (SYNC Mekanize Kesim Rehberi)*'ne (810480) bakın.

3

Ölçüm birimleri:

- mm = milimetre
- % = yüzde
- seconds = saniye
- mm/min = dakika başına milimetre
- volts = volt
- inches = inç
- in/min = dakika başına inç
- A = amperaj (FineCut tabloları)

Edge start = Çalışma parçasının kenarından kesime başlanması.

4

Her kesim tablosu sıcak ve soğuk gaz akışı oranlarını listeler.

- slpm = Dakika başına standart litre
- scfh = Saat başına standart kübik fit

Hot (cutflow) = Plazma arkı açık ve kesim sırasında sabit gaz akışı gerçekleşiyor.

Cold (postflow) = Plazma arkı kapalı ve kesim tamamlanmadan önce birkaç saniye için sabit gaz akışı gerçekleşiyor. Bu akış hızı, gaz testi modu için de geçerlidir.

Sử dụng Biểu đồ Cắt (Tiếng Việt/Vietnamese)

⚠ CẢNH BÁO



NGUY HIỂM PHÁT NỔ – CẮT BẰNG NHÔM GẦN NƯỚC

Cắt dưới nước bằng khí nhiên liệu hoặc nhôm có thể gây nguy hiểm phát nổ.

- KHÔNG cắt dưới nước bằng khí nhiên liệu có chứa hydro.
- KHÔNG cắt hợp kim nhôm dưới nước hoặc trên bàn nước, trừ khi bạn có thể ngăn chặn sự tích tụ khí hydro.

Làm như vậy có thể gây nổ trong quá trình vận hành hệ thống cắt. Tham khảo *Safety and Compliance Manual (Sổ tay An toàn và Tuân thủ)* (80669C) để biết thêm thông tin.

⚠ CẢNH BÁO



NGUY HIỂM PHÁT NỔ – CẮT BẰNG KHÍ DỄ CHÁY HOẶC KHÍ Ô XY HÓA

Không sử dụng khí dễ cháy hoặc khí ô xy hóa với hệ thống Powermax. Những khí này có thể gây ra điều kiện phát nổ trong quá trình cắt plasma.

Ví dụ về khí ô xy hóa là khí ô xy. Ví dụ về các loại khí dễ cháy bao gồm acetylen, propylen, mê-tan và hydro tinh khiết. Tham khảo *Safety and Compliance Manual (Sổ tay An toàn và Tuân thủ)* (80669C) để biết thêm thông tin.

Để biết thêm thông tin

- Để biết thông tin về tích hợp hệ thống Powermax® với thiết lập cắt máy tự động của bạn, hãy tham khảo *Powermax65/85/105 SYNC Mechanized Cutting Guide (Hướng dẫn Cắt Máy tự động Powermax65/85/105 SYNC)* (810480).
- Để biết thêm thông tin về hệ thống của bạn, hãy tham khảo *Powermax65/85/105 SYNC Operator Manual (Powermax65/85/105 SYNC Sổ tay Vận hành)* (810470).

Tải về các tài liệu này tại www.hypertherm.com/docs.

Giới thiệu về biểu đồ cắt

Các biểu đồ cắt trong hướng dẫn này là một điểm khởi đầu tốt. Hãy điều chỉnh các biến số trong biểu đồ cắt khi cần để có kết quả tối ưu cho thiết bị và môi trường cắt.

Biểu đồ cắt được đi kèm cho các công việc sau:

- Cắt thép non, thép không gỉ và nhôm tại 45 A – 105 A bằng không khí sử dụng các hộp cắt tiêu chuẩn
- Cắt thép non và thép không gỉ bằng không khí sử dụng hộp FineCut

Hypertherm đã thu thập dữ liệu biểu đồ cắt bằng cách sử dụng các hộp mới và tuân thủ

Chọn lõi phun tốt nhất cho vật liệu bạn muốn cắt

Biểu đồ cắt	Độ dày vật liệu theo hệ mét (mm)											
	0,5	1	2	3	5	8	10	12	15	20	25	30
FineCut	■	■	■	■	■							
45 A	■	■	■	■	■	■	■	■	■	■	■	■
65 A			■	■	■	■	■	■	■	■	■	■
85 A				■	■	■	■	■	■	■	■	■
105 A					■	■	■	■	■	■	■	■

Chất lượng cắt tối ưu

Gần đạt chất lượng cắt tối ưu

Chất lượng cắt hoặc tốc độ cắt suy giảm

Biểu đồ cắt	Độ dày vật liệu bằng đơn vị Anh (inch)										
	0.02	0.06	1/8	1/4	3/8	1/2	5/8	3/4	1	1-1/4	1-1/2
FineCut	■	■	■	■							
45 A	■	■	■	■	■	■	■	■	■	■	■
65 A			■	■	■	■	■	■	■	■	■
85 A				■	■	■	■	■	■	■	■
105 A					■	■	■	■	■	■	■

Thành phần biểu đồ cắt

Hình minh họa sau đây chỉ rõ các thành phần trên mỗi biểu đồ cắt.

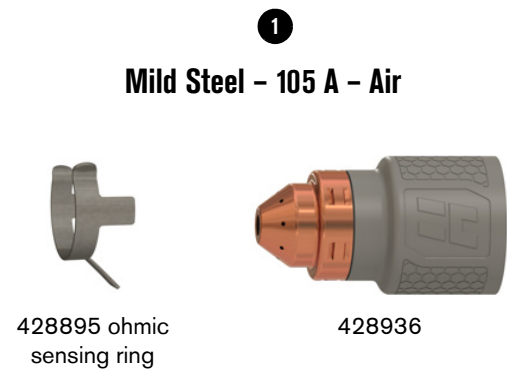

2 **Metric**

Material Thickness	Cut Height	Initial Pierce Height	Pierce Delay	Best Quality		Highest Production		Kerf Width	
				Cut Speed	Arc Voltage	Cut Speed	Arc Voltage		
mm	mm	mm	%	seconds	mm/min	volts	mm/min	volts	mm
6	3.2	6.4	200	0.5	3960	143	4880	143	2.2
20				1.0	790	153	940	152	2.8
40				Edge start		200	172	250	170

2 **English**

Material Thickness	Cut Height	Initial Pierce Height	Pierce Delay	Best Quality		Highest Production		Kerf Width	
				Cut Speed	Arc Voltage	Cut Speed	Arc Voltage		
inches	inches	inches	%	seconds	in/min	volts	in/min	volts	inches
1/4	0.125	0.25	200	0.5	156	143	192	143	0.086
3/4				1.0	33	152	40	151	0.108
1-1/2				Edge start		9	170	10	168

4 **Gas flow rate – slpm / scfh**

236 / 500	Hot (cutflow)
311 / 660	Cold (postflow)

- 1** Dạng kim loại:
- Thép non
 - Thép không gỉ
 - Nhôm
- Quy trình cắt:
- **A** = Cường độ dòng điện. Cường độ dòng điện áp dụng cho tất cả các cài đặt trên trang đó.
 - Trong biểu đồ **FineCut**, cường độ dòng điện cho từng độ dày được đưa vào biểu đồ cắt. Hướng dẫn này bao gồm các biểu đồ tốc độ cao và tốc độ thấp. Cài đặt tốc độ cao có thể đem đến chất lượng cắt tốt hơn và ít xỉ cắt hơn ở một số độ dày, nếu bạn cắt cho phép bạn cắt ở các cài đặt đó.

Loại khí đốt:

- **Không khí** (hoặc khí nitơ)

Dùng **vòng cảm biến thuần trở** để kết nối lõi phun cắt máy tự động với hệ thống kiểm soát độ cao mỏ cắt (THC). Lắp vòng cảm biến thuần trở vào lõi phun như được hiển thị. Bộ dụng cụ 428895 gồm 3 vòng cảm biến thuần trở (420580).

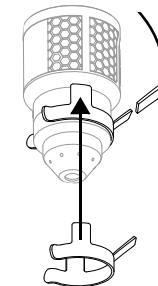

- 2** **Metric** = Đơn vị đo hệ Mét
- English** = Đơn vị đo của nước Anh
- Material Thickness** = Độ dày của phôi gia công (tấm kim loại đang cắt).
- Cut Height** = Khoảng cách giữa đầu của hộp cắt và phôi gia công trong quá trình cắt.
- Initial Pierce Height** = Khoảng cách giữa đầu của hộp cắt và phôi gia công khi mỏ cắt hoạt động, trước khi hạ xuống độ cao cắt.
- Pierce Delay** = Khoảng thời gian hồ quang plasma vẫn đứng yên ở độ cao xuyên qua trong khi cắt xuyên qua phôi gia công.
- Best Quality (Cut Speed và Arc Voltage*)** = Các cài đặt cung cấp điểm bắt đầu để đạt được chất lượng cắt tốt nhất (góc tốt nhất, ít xỉ nhất, bề mặt cắt tốt nhất). Điều chỉnh tốc độ cho ứng dụng và hệ thống cắt của bạn để có được kết quả mong muốn.
- Highest Production (Cut Speed và Arc Voltage*)** = Cài đặt giúp tăng tốc độ cắt thêm 20% – 30%. Những tốc độ này làm tăng số lượng bộ phận cắt được nhưng không nhất thiết là phải có chất lượng cắt tốt nhất có thể.
- Kerf Width** = Chiều rộng của vật liệu loại bỏ bởi quá trình cắt. Độ rộng kerf chỉ mang tính tham khảo. Hypertherm có được chúng bằng cách sử dụng cài đặt "Best Quality (Chất lượng Tốt nhất)". Sự khác biệt giữa cài đặt và thành phần vật liệu có thể khiến kết quả thực tế thay đổi so với kết quả được hiển thị trong bảng.

* Để biết thông tin về cách sử dụng điện áp hồ quang để kiểm soát độ cao cắt, hãy tham khảo *Powermax65/85/105 SYNC Mechanized Cutting Guide (Powermax65/85/105 SYNC Hướng dẫn Cắt bằng Máy)* (810480).

- 3** Đơn vị đo:
- **mm** = milimét
 - **%** = phần trăm
 - **seconds** = giây
 - **mm/min** = milimét mỗi phút
 - **volts** = vôn
 - **inches** = inch
 - **in/min** = inch mỗi phút
 - **A** = cường độ dòng điện (biểu đồ FineCut)
- Edge start** = Bắt đầu cắt từ cạnh của phôi gia công.

- 4** Mỗi biểu đồ cắt đều có liệt kê lưu lượng dòng khí nóng và lạnh.
- **slpm** = Lít tiêu chuẩn mỗi phút
 - **scfh** = Feet khối tiêu chuẩn mỗi giờ
- Hot (cutflow)** = Hồ quang Plasma đang bật và có một luồng khí ổn định trong khi cắt.
- Cold (postflow)** = Hồ quang Plasma đang tắt và có một luồng khí ổn định trong vài giây sau khi quá trình cắt hoàn thành. Lưu lượng này cũng áp dụng cho chế độ thử khí.

1 Mild Steel – 105 A – Air



428895
ohmic sensing ring

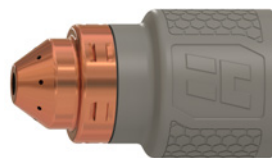

428936

Metric

Material Thickness	Cut Height	Initial Pierce Height		Pierce Delay	Best Quality		Highest Production		Kerf Width
		mm	%		mm/min	volts	mm/min	volts	
6	3.2	6.4	200	0.5	3960	143	4880	143	2.2
8					3020	144	3730	144	2.3
10				0.8	2240	145	2740	145	2.4
12					1700	146	2080	146	2.5
16				1.0	1090	149	1320	149	2.7
20					790	153	940	152	2.8
25		Edge Start			530	157	580	156	2.9
30					380	162	410	161	3.3
32					330	164	360	163	3.6
35					280	167	300	166	4.0
40					200	172	250	170	5.1

English

Material Thickness	Cut Height	Initial Pierce Height		Pierce Delay	Best Quality		Highest Production		Kerf Width
		inches	%		in/min	volts	in/min	volts	
1/4	0.125	0.250	200	0.5	156	143	192	143	0.086
3/8					94	145	116	145	0.095
1/2				0.8	61	147	75	146	0.101
5/8					43	149	53	149	0.105
3/4				1.0	33	152	40	151	0.108
7/8					26	155	30	154	0.111
1		Edge Start			20	158	22	157	0.117
1-1/8					16	161	18	160	0.126
1-1/4					13	164	14	163	0.139
1-1/2					9	170	10	168	0.183

Gas flow rate – slpm / scfh

236 / 500	Hot (cutflow)
311 / 660	Cold (postflow)

1
Stainless Steel – 105 A – Air



428895
ohmic sensing ring

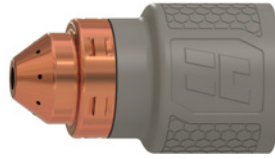

428936

2
Metric

Material Thickness	Cut Height	Initial Pierce Height		Pierce Delay	Best Quality		Highest Production		Kerf Width
		mm	%		mm/min	volts	mm/min	volts	
6	3.2	6.4	200	0.5	4700	139	5690	139	1.9
8					3250	142	3890	142	2.1
10					2180	144	2620	144	2.2
12					1550	147	1880	146	2.4
16		7.9	250	0.8	940	151	1120	150	2.6
20					660	155	790	154	2.8
25		Edge Start			460	159	530	158	2.9
30		Edge Start			330	162	360	162	2.8
32		Edge Start			300	163	330	163	2.8

2
English

Material Thickness	Cut Height	Initial Pierce Height		Pierce Delay	Best Quality		Highest Production		Kerf Width
		inches	%		in/min	volts	in/min	volts	
1/4	0.125	0.250	200	0.5	185	140	224	140	0.075
3/8					94	144	112	143	0.086
1/2					55	148	67	147	0.096
5/8					37	151	45	150	0.103
3/4		0.310	250	1.3	28	154	34	153	0.109
7/8					22	157	27	156	0.113
1		Edge Start			17	160	20	159	0.114
1-1/8		Edge Start			14	161	16	161	0.113
1-1/4		Edge Start			12	163	13	163	0.110

4
Gas flow rate – slpm / scfh

236 / 500	Hot (cutflow)
311 / 660	Cold (postflow)

1 Aluminum – 105 A – Air



428895
ohmic sensing ring



428936

Metric

Material Thickness	Cut Height	Initial Pierce Height		Pierce Delay	Best Quality		Highest Production		Kerf Width
		mm	%		mm/min	volts	mm/min	volts	
6	3.2	6.4	200	0.5	5660	146	6730	146	2.3
8					3760	148	4500	147	2.4
10				2590	149	3230	148	2.4	
12				1930	151	2490	149	2.5	
16		1320	156	1650	153	2.5			
20		1020	160	1190	157	2.6			
25		Edge Start			660	166	810	163	2.7
30		Edge Start			430	172	560	168	3.0
32	Edge Start			380	174	510	170	3.1	

English

Material Thickness	Cut Height	Initial Pierce Height		Pierce Delay	Best Quality		Highest Production		Kerf Width
		inches	%		in/min	volts	in/min	volts	
1/4	0.125	0.250	200	0.5	223	146	265	146	0.093
3/8					110	149	136	148	0.096
1/2				70	152	91	150	0.098	
5/8				52	155	66	153	0.100	
3/4		43	159	50	156	0.102			
7/8		Edge Start			34	162	40	159	0.105
1		Edge Start			26	166	31	163	0.109
1-1/8		Edge Start			19	170	24	167	0.114
1-1/4	Edge Start			15	174	20	170	0.122	

Gas flow rate – slpm / scfh

236 / 500	Hot (cutflow)
311 / 660	Cold (postflow)

1
Mild Steel - 85 A - Air



428895
ohmic sensing ring

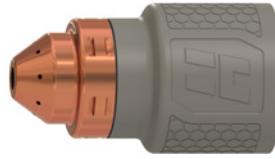

428934

Metric

Material Thickness	Cut Height	Initial Pierce Height		Pierce Delay	Best Quality		Highest Production		Kerf Width
					Cut Speed	Arc Voltage	Cut Speed	Arc Voltage	
mm	mm	mm	%	seconds	mm/min	volts	mm/min	volts	mm
3	3.2	3.8	120	0.0	6930	134	9580	131	1.5
4				0.2	5560	134	7140	132	1.7
6					3560	135	4220	134	1.9
8				0.5	2360	136	2820	135	2.1
10		4.8	150		1630	137	2030	137	2.3
12					1240	138	1520	138	2.4
16		840	142		970	142	2.6		
20		6.4	200	1.5	580	147	660	145	2.8
25		Edge Start			360	153	430	150	3.0
30					200	159	300	155	3.4

English

Material Thickness	Cut Height	Initial Pierce Height		Pierce Delay	Best Quality		Highest Production		Kerf Width
					Cut Speed	Arc Voltage	Cut Speed	Arc Voltage	
inches	inches	inches	%	seconds	in/min	volts	in/min	volts	inches
10 GA	0.125	0.150	120	0.2	250	134	334	132	0.063
3/16					185	134	226	133	0.070
1/4				0.5	130	135	153	134	0.077
3/8					70	136	86	136	0.088
1/2		0.188	150	1.0	46	139	55	139	0.096
5/8					34	142	39	142	0.103
3/4		0.250	200	1.5	25	146	28	144	0.108
7/8		Edge Start			19	150	22	147	0.114
1					13	153	17	150	0.120
1-1/8					9	157	13	153	0.128
1-1/4	6				161	10	157	0.139	

Gas flow rate - slpm / scfh

212 / 450	Hot (cutflow)
264 / 560	Cold (postflow)

1
Stainless Steel - 85 A - Air



428895
ohmic sensing ring



428934

2
Metric

Material Thickness	Cut Height	Initial Pierce Height		Pierce Delay	Best Quality		Highest Production		Kerf Width
		mm	%		seconds	Cut Speed	Arc Voltage	Cut Speed	
3	3.2	3.8	120	0.2	8100	132	9860	131	1.3
4					6220	133	7570	132	1.6
6					3630	135	4470	134	2.0
8					2260	137	2790	136	2.3
10		4.8	150	0.5	1500	139	1880	138	2.4
12					1040	142	1350	140	2.5
16					690	147	790	144	2.5
20					Edge Start		480	151	530
25	Edge Start		300	155	380	152	3.5		

2
English

Material Thickness	Cut Height	Initial Pierce Height		Pierce Delay	Best Quality		Highest Production		Kerf Width		
		inches	%		seconds	Cut Speed	Arc Voltage	Cut Speed		Arc Voltage	
10 GA	0.125	0.150	120	0.2	275	133	335	131	0.060		
3/16					199	134	243	133	0.071		
1/4					131	135	161	134	0.082		
3/8					65	139	81	137	0.094		
1/2		0.188	150	1.0	36	142	47	141	0.098		
5/8					27	146	32	144	0.098		
3/4					Edge Start		21	150	23	147	0.102
7/8					Edge Start		16	153	18	150	0.114
1	Edge Start		11	155	15	152	0.141				

4
Gas flow rate - slpm / scfh

212 / 450	Hot (cutflow)
264 / 560	Cold (postflow)

1
Aluminum - 85 A - Air

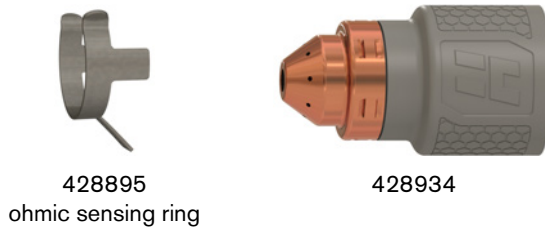

Metric

2

Material Thickness	Cut Height	Initial Pierce Height		Pierce Delay	Best Quality		Highest Production		Kerf Width
		mm	%		seconds	Cut Speed	Arc Voltage	Cut Speed	
3	3.2	3.8	120	0.2	7980	137	9520	135	1.9
4					6050	138	7470	136	2.0
6					3630	140	4750	138	2.2
8					2440	142	3250	141	2.4
10		4.8	150	0.5	1780	145	2390	143	2.5
12					1400	148	1850	146	2.6
16					940	154	1190	150	2.7
20					Edge Start		580	158	890
25	Edge Start		380	162	530	159	3.0		

3

English

2

Material Thickness	Cut Height	Initial Pierce Height		Pierce Delay	Best Quality		Highest Production		Kerf Width		
		inches	%		seconds	Cut Speed	Arc Voltage	Cut Speed		Arc Voltage	
1/8	0.125	0.150	120	0.2	300	137	360	136	0.076		
1/4					133	140	174	139	0.089		
3/8					75	144	101	143	0.097		
1/2					51	149	68	146	0.102		
5/8		0.188	150	1.0	38	153	48	150	0.106		
3/4					Edge Start		26	157	37	154	0.109
7/8					Edge Start		19	160	29	157	0.113
1					Edge Start		15	162	20	159	0.119

3

Gas flow rate - slpm / scfh **4**

212 / 450	Hot (cutflow)
264 / 560	Cold (postflow)

1 Mild Steel – 65 A – Air



428895
ohmic sensing ring

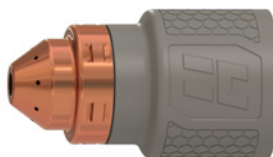

428930

Metric

Material Thickness	Cut Height	Initial Pierce Height		Pierce Delay	Best Quality		Highest Production		Kerf Width
		mm	%		mm/min	volts	mm/min	volts	
3	3.2	3.8	120	0.1	5330	133	6250	132	1.3
4					4220	133	5000	131	1.4
6					2570	133	3200	132	1.5
8					1550	135	2130	133	1.7
10					1040	137	1500	135	1.9
12		840	139	1120	137	2.0			
16		6.4	200	2.0	560	145	660	143	2.3
20		Edge Start			380	151	430	148	2.5
25	Edge Start			200	155	280	153	2.8	

English

Material Thickness	Cut Height	Initial Pierce Height		Pierce Delay	Best Quality		Highest Production		Kerf Width
		inches	%		in/min	volts	in/min	volts	
10 GA	0.125	0.150	120	0.1	191	133	225	132	0.053
3/16					138	133	166	131	0.057
1/4					93	133	117	132	0.062
3/8					44	136	64	134	0.072
1/2					30	140	40	138	0.081
5/8		0.250	200	2.0	22	145	27	143	0.089
3/4		Edge Start			16	150	19	147	0.097
7/8		Edge Start			11	153	14	151	0.104
1	Edge Start			8	155	10	153	0.110	

Gas flow rate – slpm / scfh

193 / 410	Hot (cutflow)
243 / 515	Cold (postflow)

1
Stainless Steel - 65 A - Air



428895
ohmic sensing ring

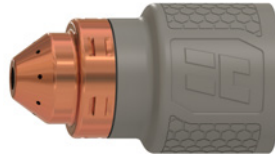

428930

Metric

Material Thickness	Cut Height	Initial Pierce Height		Pierce Delay	Best Quality		Highest Production		Kerf Width
					Cut Speed	Arc Voltage	Cut Speed	Arc Voltage	
mm	mm	mm	%	seconds	mm/min	volts	mm/min	volts	mm
2	3.2	3.8	120	0.1	8760	132	10820	131	0.8
3					7650	132	9730	131	1.1
4					5160	133	6120	131	1.3
6					2440	133	2720	132	1.6
8		1350	135	1550	134	1.8			
10		4.8	150	0.7	940	137	1120	136	2.0
12					740	139	890	138	2.1
16		Edge Start				480	144	510	143
20	Edge Start				330	149	360	148	2.5

English

Material Thickness	Cut Height	Initial Pierce Height		Pierce Delay	Best Quality		Highest Production		Kerf Width	
					Cut Speed	Arc Voltage	Cut Speed	Arc Voltage		
inches	inches	inches	%	seconds	in/min	volts	in/min	volts	inches	
10 GA	0.125	0.150	120	0.1	241	132	295	131	0.047	
3/16					150	133	171	132	0.055	
1/4					86	134	95	133	0.064	
3/8					40	136	47	135	0.075	
1/2		0.188	150	1.2	27	140	31	139	0.082	
5/8					Edge Start				19	144
3/4		Edge Start				14	148	15	147	0.096

Gas flow rate - slpm / scfh

193 / 410	Hot (cutflow)
243 / 515	Cold (postflow)

1
Aluminum - 65 A - Air

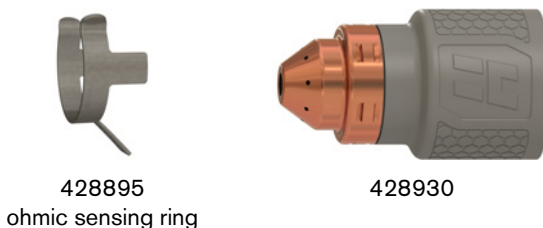

Metric

Material Thickness	Cut Height	Initial Pierce Height		Pierce Delay	Best Quality		Highest Production		Kerf Width
					Cut Speed	Arc Voltage	Cut Speed	Arc Voltage	
mm	mm	mm	%	seconds	mm/min	volts	mm/min	volts	mm
2	3.2	3.8	120	0.1	9270	134	10800	133	1.4
3					7540	134	8920	133	1.5
4					5380	135	6880	133	1.5
6					2900	137	4110	135	1.6
8		0.5	1780	139	2590	137	1.7		
10		4.8	150	0.7	1220	142	1750	139	1.8
12					940	145	1320	142	1.9
16					Edge Start		610	151	810
20		Edge Start		380	157	530	153	2.4	

English

Material Thickness	Cut Height	Initial Pierce Height		Pierce Delay	Best Quality		Highest Production		Kerf Width		
					Cut Speed	Arc Voltage	Cut Speed	Arc Voltage			
inches	inches	inches	%	seconds	in/min	volts	in/min	volts	inches		
1/16	0.125	0.150	120	0.1	365	134	428	133	0.056		
1/8					280	134	337	133	0.059		
1/4					104	137	149	135	0.064		
3/8					52	141	75	138	0.069		
1/2		0.188	150	1.2	34	146	48	143	0.076		
5/8					Edge Start		25	151	33	147	0.083
3/4					Edge Start		17	155	23	152	0.092

Gas flow rate - slpm / scfh

193 / 410	Hot (cutflow)
243 / 515	Cold (postflow)

1
Mild Steel – 45 A – Air

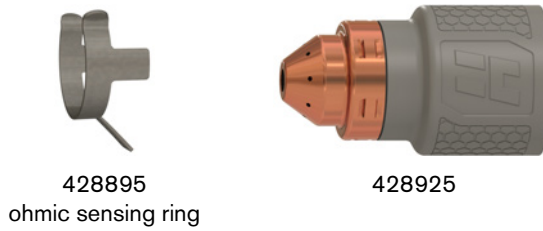

Metric

2

Material Thickness	Cut Height	Initial Pierce Height		Pierce Delay	Best Quality		Highest Production		Kerf Width
		mm	%		Cut Speed	Arc Voltage	Cut Speed	Arc Voltage	
mm	mm	mm	%	seconds	mm/min	volts	mm/min	volts	mm
0.5	3.2	3.8	120	0.0	8890	137	12500	135	1.1
1				0.1	8890	138	10670	138	1.4
1.5					8890	138	10190	139	1.5
2				0.2	6600	139	7620	140	1.7
3				0.4	3630	141	4830	139	1.8
4					2260	142	3400	138	1.9
6				0.6	1240	141	2010	140	1.9

3

English

2

Material Thickness	Cut Height	Initial Pierce Height		Pierce Delay	Best Quality		Highest Production		Kerf Width
		inches	%		Cut Speed	Arc Voltage	Cut Speed	Arc Voltage	
inches	inches	inches	%	seconds	in/min	volts	in/min	volts	inches
26 GA	0.125	0.150	120	0.0	350	137	501	135	0.044
22 GA					350	137	445	137	0.049
18 GA				0.1	350	138	408	138	0.057
16 GA					350	138	398	139	0.061
14 GA				0.2	278	139	318	140	0.065
12 GA				0.4	173	140	219	140	0.071
10 GA					115	141	162	139	0.073
3/16				0.5	68	142	107	138	0.074
1/4				0.6	46	141	74	141	0.075

3

Gas flow rate – slpm / scfh

4

182 / 385	Hot (cutflow)
217 / 460	Cold (postflow)

1
Stainless Steel - 45 A - Air

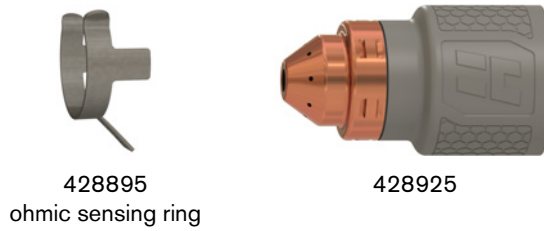

Metric

Material Thickness	Cut Height	Initial Pierce Height		Pierce Delay	Best Quality		Highest Production		Kerf Width
					Cut Speed	Arc Voltage	Cut Speed	Arc Voltage	
mm	mm	mm	%	seconds	mm/min	volts	mm/min	volts	mm
0.5	3.2	3.8	120	0.0	8890	127	12700	125	1.1
1				0.1	8890	134	10770	132	0.8
1.5					8890	138	10110	137	0.7
2				0.2	6220	140	8990	139	0.8
3				0.4	3230	141	4620	140	1.4
4				0.5	1960	140	2410	139	2.2
6				0.6	860	142	970	141	2.4

English

Material Thickness	Cut Height	Initial Pierce Height		Pierce Delay	Best Quality		Highest Production		Kerf Width
					Cut Speed	Arc Voltage	Cut Speed	Arc Voltage	
inches	inches	inches	%	seconds	in/min	volts	in/min	volts	inches
26 GA	0.125	0.150	120	0.0	350	127	501	125	0.045
22 GA					350	131	445	130	0.035
18 GA				0.1	350	136	408	135	0.027
16 GA					350	138	401	137	0.026
14 GA				0.2	248	140	357	139	0.030
12 GA				0.4	145	141	214	140	0.048
10 GA					94	141	124	140	0.072
3/16				0.5	55	139	63	138	0.102
1/4				0.6	30	144	35	144	0.082

Gas flow rate - slpm / scfh

182 / 385	Hot (cutflow)
217 / 460	Cold (postflow)

1
Aluminum - 45 A - Air

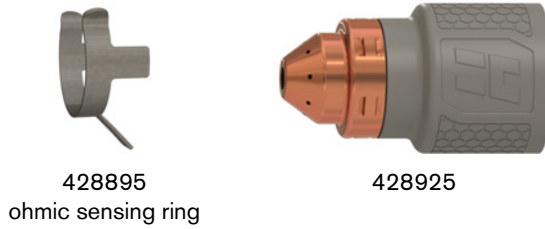

Metric

Material Thickness	Cut Height	Initial Pierce Height		Pierce Delay	Best Quality		Highest Production		Kerf Width
					Cut Speed	Arc Voltage	Cut Speed	Arc Voltage	
mm	mm	mm	%	seconds	mm/min	volts	mm/min	volts	mm
1	3.2	3.8	120	0.0	8260	131	11400	128	1.6
2				0.1	5970	140	9040	137	1.8
3				0.1	3350	146	6400	143	1.9
4				0.1	2210	150	4600	146	1.9
6				0.2	1240	151	2570	145	2.0

English

Material Thickness	Cut Height	Initial Pierce Height		Pierce Delay	Best Quality		Highest Production		Kerf Width
					Cut Speed	Arc Voltage	Cut Speed	Arc Voltage	
inches	inches	inches	%	seconds	in/min	volts	in/min	volts	inches
1/32	0.125	0.150	120	0.0	325	129	449	126	0.062
1/16					325	137	406	134	0.069
3/32				0.1	183	143	312	140	0.073
1/8					121	147	238	144	0.074
1/4				0.2	46	150	93	143	0.081

Gas flow rate - slpm / scfh

182 / 385	Hot (cutflow)
217 / 460	Cold (postflow)

1
Mild Steel – FineCut High Speed – Air



428895
ohmic sensing ring

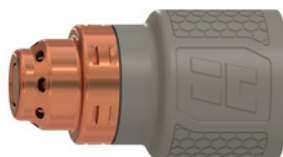

428926

2
Metric

Material Thickness	Current	Cut Height	Initial Pierce Height		Pierce Delay	Best Quality		Kerf Width			
						Cut Speed	Arc Voltage				
mm	A	mm	mm	%	seconds	mm/min	volts	mm			
0.5	40	3.5	3.5	100	0.0	8900	90	0.8			
0.6						8900	90	0.8			
0.8						8900	90	0.6			
1						8890	90	0.6			
1.5	45				3.5	3.5	100	0.2	6550	88	0.5
2								0.3	5260	88	0.5
3								0.4	2750	90	0.8
4								0.6	2250	88	0.8

2
English

Material Thickness	Current	Cut Height	Initial Pierce Height		Pierce Delay	Best Quality		Kerf Width			
						Cut Speed	Arc Voltage				
inches	A	inches	inches	%	seconds	in/min	volts	inches			
26 GA	40	0.14	0.14	100	0.0	350	90	0.033			
24 GA						350	90	0.032			
22 GA						350	90	0.026			
20 GA						350	90	0.024			
18 GA	45				0.14	0.14	100	0.1	350	89	0.020
16 GA								0.2	250	88	0.021
14 GA								0.3	220	88	0.021
12 GA								0.4	115	91	0.032
10 GA		0.14	0.14	100				0.5	100	89	0.031

4
Gas flow rate – slpm / scfh

162 / 343	Hot (cutflow)
180 / 382	Cold (postflow)

1
Stainless Steel - FineCut High Speed - Air



428895
ohmic sensing ring

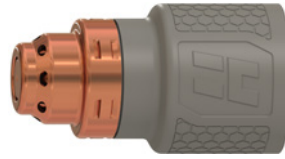

428926

Metric

2

Material Thickness	Current	Cut Height	Initial Pierce Height		Pierce Delay	Best Quality		Kerf Width
			mm	%		Cut Speed	Arc Voltage	
mm	A	mm	mm	%	seconds	mm/min	volts	mm
0.5	40	0.5	3.5	700	0.0	8900	64	0.7
0.6						8900	65	0.6
0.8						8900	65	0.5
1	45				0.1	8890	64	0.4
1.5					0.3	6320	64	0.4
2					0.4	4830	65	0.4
3					0.5	2550	71	0.6
4	0.7				1050	71	0.5	

3

English

2

Material Thickness	Current	Cut Height	Initial Pierce Height		Pierce Delay	Best Quality		Kerf Width
			inches	%		Cut Speed	Arc Voltage	
inches	A	inches	inches	%	seconds	in/min	volts	inches
26 GA	40	0.02	0.14	700	0.0	350	64	0.028
24 GA						350	65	0.024
22 GA						350	65	0.020
20 GA	45				0.1	350	65	0.016
18 GA					0.2	350	62	0.012
16 GA					0.3	240	64	0.017
14 GA					0.4	200	65	0.017
12 GA	0.5				120	71	0.026	
10 GA	0.6	75	71	0.023				

3

Gas flow rate - slpm / scfh **4**

162 / 343	Hot (cutflow)
180 / 382	Cold (postflow)

1
Mild Steel – FineCut Low Speed – Air



428895
ohmic sensing ring

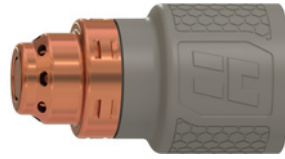

428926

2
Metric

Material Thickness	Current	Cut Height	Initial Pierce Height		Pierce Delay	Best Quality		Kerf Width						
						Cut Speed	Arc Voltage							
mm	A	mm	mm	%	seconds	mm/min	volts	mm						
0.5	30	3.5	3.5	100	0.0	3800	98	1.0						
0.6						3800	97	1.0						
0.8						3800	95	1.0						
1	3800					95	0.9							
1.5	40				3.5	3.5	100	0.2	3800	94	1.0			
2								0.3	2370	93	1.1			
3	45							3.5	3.5	100	0.4	2750	90	0.8
4											0.6	2250	88	0.8

2
English

Material Thickness	Current	Cut Height	Initial Pierce Height		Pierce Delay	Best Quality		Kerf Width			
						Cut Speed	Arc Voltage				
inches	A	inches	inches	%	seconds	in/min	volts	inches			
26 GA	30	0.14	0.14	100	0.0	150	98	0.042			
24 GA						150	97	0.039			
22 GA						150	95	0.040			
20 GA	150					95	0.038				
18 GA	40				0.14	0.14	100	0.1	150	94	0.035
16 GA								0.2	150	94	0.038
14 GA								0.3	90	93	0.042
12 GA	45							0.14	0.14	100	0.4
10 GA		0.5	100	89							0.031

4
Gas flow rate – slpm / scfh

162 / 343	Hot (cutflow)
180 / 382	Cold (postflow)

1
Stainless Steel – FineCut Low Speed – Air



428895
ohmic sensing ring

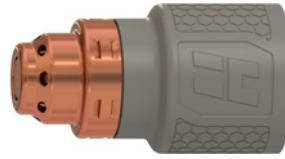

428926

Metric

2

Material Thickness	Current	Cut Height	Initial Pierce Height		Pierce Delay	Best Quality		Kerf Width
						Cut Speed	Arc Voltage	
mm	A	mm	mm	%	seconds	mm/min	volts	mm 3
0.5	30	0.5	3.5	700	0.0	3800	74	0.9
0.6						3800	73	0.8
0.8						3800	71	0.7
1	40				0.1	3770	71	0.7
1.5					0.3	3570	71	0.6
2					0.4	2830	71	0.7
3					0.5	2550	71	0.6
4	45				0.7	1050	71	0.5

English

2

Material Thickness	Current	Cut Height	Initial Pierce Height		Pierce Delay	Best Quality		Kerf Width
						Cut Speed	Arc Voltage	
inches	A	inches	inches	%	seconds	in/min	volts	inches 3
26 GA	30	0.02	0.14	700	0.0	150	74	0.035
24 GA						150	73	0.033
22 GA						150	71	0.030
20 GA	40				0.1	150	71	0.026
18 GA					0.2	145	71	0.026
16 GA					0.3	140	71	0.025
14 GA					0.4	110	71	0.028
12 GA	45				0.5	120	71	0.026
10 GA		0.6	75	71	0.023			

Gas flow rate – slpm / scfh **4**

162 / 343	Hot (cutflow)
180 / 382	Cold (postflow)